



Operations Manager User Guide 22.11.0





Contents	2
Copyright ©	10
Document Revision History	11
Safety & FCC Statement	12
Safety Statement	12
FCC Warning Statement	12
About This User Guide	14
Installation And Connection	15
Power Connection	16
Dual Power Supply	18
SNMP Alerts for Power-related Events	19
SNMP Alert Configuration	19
Device Status LEDs	20
Connecting to the Network	22
Serial Connection	23
Cellular Connectivity	24
Installing A New SIM Card	24
Cellular Modem Antenna Gain Specifications	25
Reset and Erase	26
Initial Settings	27
Default Settings	28
Using the Web GUI	29
Management Console Connection via CLI	31



Accessing the Web GUI CLI Terminal	31
Change the Root Password	32
Disable a Root User	34
Change Network Settings	35
MONITOR Menu	39
System Log	40
LLDP CDP Neighbors	41
Triggered Playbooks	42
ACCESS Menu	43
Local Terminal	44
Access Serial Ports	45
Quick Search	46
Access Using Web Terminal or SSH	46
Serial Port Logging	47
CONFIGURE Menu	49
Configure Serial Ports	50
Edit Serial Ports	51
Autodiscovery	53
Local Management Consoles	57
Lighthouse Enrollment	59
Manual Enrollment Using UI	60
Manual Enrollment Using the CLI	61
Playbooks	62
Create Or Edit a Playbook	62
PDUs	67
Add and Configure a PDU	67
PDU Operation	69



System Alerts	70
System Alerts - General	71
Authentication	71
Configuration	71
System Alerts - Power	72
Enable Power Supply Syslog Alerts	72
System Alerts - Temperature	74
Configure SNMP System Temperature Alerts	74
System Alerts - Networking (Connection Status)	76
Configure Signal Strength Alerts	76
Network Connections	78
Network Interfaces	79
DNS Configuration	80
Configure DNS via the Web UI	80
Configure DNS via the Command Line	81
Dual SIM	83
Display SIM Status and Signal Strength	83
Installing A New SIM Card	85
Select The Active SIM (Manual Failover Mode)	86
Select The Primary SIM (Automatic Failover Mode)	87
Dual SIM Automatic Failover	89
Failover Modes	91
Activate or Configure Automatic Failover	92
Cellular Interface Policy Settings	93
Network Aggregates - Bonds and Bridges	95
Bridges	95
Bonds	98
Spanning Tree Protocol	102
Enable STP in a Bridge	103
Bridge With STP Enabled - UI	103
Bridge With STP Enabled - OGCLI	103



Bridge With STP Disabled - OGCLI	104
IPsec Tunnels	105
Create, Add or Edit IPsec Tunnels	105
Static Routes	110
Configure Static Routes	111
Managing Static Routes via Command Line	112
Network Resilience	114
Out Of Band Failover	115
Enable Out-of-Band Failover	115
DNS Queries on a Dormant Failover Interface	117
OOB Failover Types & Failover Behavior	118
IP Passthrough	120
User Management	122
Groups	123
Permission Changes in the Web UI	123
Understanding Access Rights	123
Understanding Serial Port Access	128
Create a New Group	131
Edit an Existing Group	133
Local Users	134
Create a New User With Password	135
Create a New User With No Password (Remote Authentication)	136
Modify An Existing User Account With Password	136
Manage SSH Authorized Keys for a User Account	137
Delete a User's Account	138
Remote Authentication	139
Configure RADIUS Authentication	140
Configure TACACS+ Authentication	141
Configure LDAP Authentication	143
Local Password Policy	145
Set Password Complexity Requirements	146

Set Password Expiration Interval	147
Password Policy Implementation Rules	148
Services	150
Brute Force Protection	151
Configure Brute Force Protection	151
Viewing Current Bans	152
Managing Brute Force Protection via Command Line	152
HTTPS Certificate	154
Network Discovery Protocols	156
Routing	158
Dynamic Routing	158
Static Routing (via the ogcli)	159
SSH	161
Unauthenticated SSH to Serial Ports	162
Enable Unauthenticated SSH	162
Enable SSH	163
Enable/Disable	163
Connecting Directly to Serial Ports	164
Feature Persist	165
Properties and Settings	165
Syslog	168
Add a New Syslog Server	168
Global Serial Port Settings	169
Edit or Delete an Existing Syslog Server	170
Session Settings	171
File Server	173
Enable TFTP Service	173
Update The TFTP Service Storage Location	174
SNMP Service	176
SNMP Alert Managers	177
Multiple SNMP Alert Managers	178



Create or Delete an SNMP Manager	178
New SNMP Alert Manager Page Definitions	179
Firewall	181
Firewall Management	182
Firewall Zone Settings	183
Port Forwarding	183
Manage Custom Rules	184
Interzone Policies	185
Create an Interzone Policy	185
Edit or Delete an Interzone Policy	187
Customized Zone Rules	187
System	188
Administration	189
Date & Time	190
Manual Date & Time Set	191
NTP Configuration & Authentication	191
CLI Commands Associated with NTP Configuration	193
Factory Reset	195
Reboot	196
Export Configuration	197
Export Configuration via Web UI	197
Export Configuration via ogcli	198
Control The Export Of Sensitive Data	198
Lighthouse Node Backup	199
Restore Configuration	200
Restore Configuration Via Web UI	200
Import Configuration via ogcli	202
System Upgrade	203
Upgrade Via Fetch From Server	204
Upgrade Via Upload	204



Advanced Options	205
Communicating With The Cellular Modem	206
Opengear CLI Guide	208
Getting Started with ogcli	208
Basic Syntax	209
Common Configuration Examples	215
Config Shell Guide	222
Start and End a Config Shell Session	222
Navigate in the Config Shell	223
Fields, Entities and Contexts	223
Global Context Commands	225
Entity Context Commands	225
Apply or Discard Field Changes	226
Operations	227
Supported Entities	227
Example CLI Commands	229
Configuring a Port	232
Advanced Portmanager PM Shell Guide	233
Running pmshell	233
pmshell Commands	234
Custom Control Codes for Serial Ports	235
Configure Custom Control Codes	235
Configure Control Codes for a Specified Port (CLI Examples)	236
Configure a Control Code Value for All Ports	237
Docker	238
Cron	239
Options:	239
Initial Provisioning via USB Key	241
EULA and GPL	243



UI Button Definitions	244
-----------------------------	-----



Copyright ©

Opengear Inc. 2022. All Rights Reserved.

Information in this document is subject to change without notice and does not represent a commitment on the part of Opengear. Opengear provides this document “as is,” without warranty of any kind, expressed or implied, including, but not limited to, the implied warranties of fitness or merchantability for a particular purpose.

Opengear may make improvements and/or changes in this manual or in the product (s) and/or the program(s) described in this manual at any time. This product could include technical inaccuracies or typographical errors. Changes are periodically made to the information herein; these changes may be incorporated in new editions of the publication.

22.11.0	Copyright ©	10
---------	-------------	----

Document Revision History

Document Version Number	Revision Date	Description
22.11.0	November 2022	Updates to: Group Permissions - enhancements NTP Configuration added Serial Port logging data counters Serial Port autodiscovery System Alerts - UI layout changes



Safety & FCC Statement

Safety Statement

Please take care to follow the safety precautions below when installing and operating the Operations Manager:

- Do not remove the metal covers. There are no operator serviceable components inside. Opening or removing the cover may expose you to dangerous voltage which may cause fire or electric shock. Refer all service to Opengear qualified personnel.
- To avoid electric shock the power cord protective grounding conductor must be connected through to ground.
- Always pull on the plug, not the cable, when disconnecting the power cord from the socket.

Do not connect or disconnect the appliance during an electrical storm. Also use a surge suppressor or UPS to protect the equipment from transients.

FCC Warning Statement

This device complies with Part 15 of the FCC rules. Operation of this device is subject to the following conditions: (1) This device may not cause harmful interference, and (2) this device must accept any interference that may cause undesired operation.

	Proper back-up systems and necessary safety devices should be utilized to protect against injury, death or property damage due to system failure. Such protection is the responsibility of the user.
---	--

22.11.0	Safety & FCC Statement	12
---------	------------------------	----



This device is not approved for use as a life-support or medical system.

Any changes or modifications made to this device without the explicit approval or consent of Opengear will void Opengear of any liability or responsibility of injury or loss caused by any malfunction.

This equipment is for indoor use and all the communication wiring are limited to inside of the building.



About This User Guide

This user guide covers the Opengear Operations Manager products, including the OM2200 family of rack-mountable appliances (available with combinations of up to 48 serial ports and 24 Ethernet ports) and the OM1200 family of small form-factor appliances (available with combinations up to 8 serial and 8 Ethernet ports).

This manual is up to date for the 22.11.0 firmware release. When using a minor release there may or may not be a specific version of the user guide for that release.

The current Operations Manager user guide can be found [here](#).

22.11.0	About This User Guide	14
---------	-----------------------	----



Installation And Connection

This section describes how to install the appliance hardware and connect it to controlled devices.

22.11.0	Installation And Connection	15
---------	-----------------------------	----



Power Connection

OM2200 devices may be powered by either AC or 12V DC power supply. The OM1200 is available with 12V DC power only.

AC Powered OM2200s have dual power inlets with auto failover built in. These power supplies each accept AC input voltage between 100 and 240 VAC with a frequency of 50 or 60 Hz. The OM2224-24E-10G-L draws a maximum of 48W, while non-24E are less than 30W.

Two IEC AC power sockets are located on the power side of the metal case, and these IEC power inlets use conventional IEC AC power cords.

Note: Country specific IEC power cords are included with the AC OM2200.

See also ["Dual Power Supply" on page 18](#) and ["System Alerts - Power" on page 72](#).

Operations Manager Platform (OM2200) Environmental And Power	
Power Supply	Dual AC or 12V DC
Power Draw	48 Watts for -24E, others <30W
Operating conditions	Temperature 5~50C, Rel Humidity 5~90%
Cooling	Passive
Environmental Sensors	Smart Controller with multi-zone temperature sensors
	Supervisory environmental controller with safety power down.
Power Draw Sensors	Active multi-zone power draw monitoring



DC Powered OM1200

All OM1200 devices are shipped with a 12VDC to universal AC (multi-country clips) wall adapter and a barrel-jack connector. Additional AC to DC adapters may be ordered.

Operations Manager Platform (OM1200) Environmental And Power	
Power Supply	12V DC
Power Draw	< 25 Watts
Operating conditions	Temperature 5~50C, Rel Humidity 5~90%
Cooling	Passive
Environmental Sensors	Smart Controller with multi-zone temperature sensors.
	Auto-shutdown/re-boot on severe thermal events
Power Draw Sensors	Active multi-zone power draw monitoring















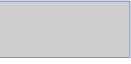



Dual Power Supply

Dual Power Supply can provide power redundancy for devices, especially those that may operate in harsher environments. A secondary power supply provides redundancy for the device if one PSU is unplugged or in the event of a failure.















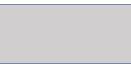

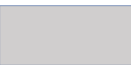

LED Power Status Indicator

The power LED indicator requires no configuration and will display the dual power status on any Operations Manager device with a dual power supply.

On a device with a **single** PSU (power supply unit) *or*, a **dual** PSU device has power connected to *two* PSUs, the LED power status indicator should be green at all times.

If a **dual** PSU device has power connected to *one* PSU (power supply unit), the LED power status indicator is colored amber indicating that the unit has no redundancy in the event of a power failure.



SNMP Alerts for Power-related Events

The System Voltage Range SNMP alert is triggered when there is a change in power status such as a system reboot or when the voltage on either power supply leaves or enters the configured range of the System Voltage alert.



SNMP Alert Configuration



The System Voltage Range SNMP alert is configured in the Configure > SNMP Alerts page, see "[System Alerts - Power](#)" on page 72.

22.11.0	Installation And Connection	19
---------	-----------------------------	----

Device Status LEDs

The LED states shown below are determined through infod status and config-server data. The config server holds a configurable threshold value for the Cell LED Amber / Green light, and modem enabled / disabled information.

Status LEDs					
LED Condition					
	LED Off	Amber Flashing	Amber Solid	Green Flashing	Green Solid
Power 	Device is off.		On a dual power supply system: Only one PSU is connected.		On a single power supply system: power is connected. On a dual power supply system: Redundant power is connected.
Heartbeat 	Device has halted.	Device is booting.		Normal operation.	Device is halted.
Network 	No active network connection	Device is fail-over starting.	Device is in failover.	Normal network connection is stopping or normal network is up and failover is stopping.	Network is connected.

Status LEDs (continued).					
LED Condition					
	LED Off	Amber Flashing	Amber Solid	Green Flashing	Green Solid
Cellular Interface 	Cellular is not in use.	Cell is starting and signal is below threshold. The LED signal threshold config is set to 50%.	Cell is connected and signal is below threshold. The LED signal threshold config is set to 50%.	Cell is starting and signal is above, or equal to the threshold.	Cell is connected and signal is above, or equal to the threshold.
IOIO 				Any serial activity is received, on either console/usb console or device serial ports.	
Cloud / Internet 	Not implemented.				

Note: The amber LED signal threshold config is set to 50%.of normal signal strength.

For information on the setting of network and power alert thresholds, see:

["System Alerts - Networking \(Connection Status\)" on page 76](#)

["System Alerts - Power" on page 72](#)



Connecting to the Network

All Operations Manager products have two network connections labeled NET1 and NET2. In the OM2200 there are options for copper wiring (on a standard RJ-45 connector) and fiber (through a standard SFP module).

The network connections on the OM2200 are located on the serial port side of the unit. Connect the provided shielded CAT5 cable to the NET1 to a computer or into your network for initial configuration. By default NET1 and NET2 are enabled.

You can use either 10/100/1000BaseT over Cat5 or fiber-optical transceiver (1Gbps) in the SFP slot for NET1 or NET2 on OM2200 (non-10G) and OM1208-8E.

22.11.0	Installation And Connection	22
---------	-----------------------------	----



Serial Connection

OM1200

Serial Ports:

The serial connections feature RS-232 with software selectable pin outs (Cisco straight –X2 or Cisco reversed –X1). Connect serial devices with the appropriate STP cables.

Console Ports:

RJ45 RS232 Cisco straight X2 pinout serial ports

OM2200

Serial Ports:

RJ45 RS-232 Console Port (50 to 230,400 bps, software selectable Cisco-straight or Cisco-rolled pinout)

Local Console Ports:

1 x micro USB 2.0 Console Port and 1 x RJ45 Serial (Straight Pinout)



Cellular Connectivity

The Operations Manager products offer an optional global cellular LTE interface (models with -L suffix). The cellular interface is certified for global deployments with most carriers and provides a CAT12 LTE interface supporting most frequencies in use. To activate the cellular interface, you should contact your local cellular carrier and activate a data plan associated to the SIM installed.

For -L models, attach the 4G cellular antennas to the unit's SMA antenna sockets on the power face (or to the extension RF cables) before powering on. Insert the 2FF SIM card on the power face with the contact facing up. Use the left SIM socket first.

Installing A New SIM Card

Before installing a new SIM card, the OM must first be powered down. This can be done by switching off the power supply and waiting until the OM has shut-down. Install the new SIM card into its slot, then restart the OM.

Note: The OM will not recognize the new SIM card unless a shut-down and restart is performed. The new SIM card will be read during start-up.



Cellular Modem Antenna Gain Specifications

OM1200 antenna gain and collocated radio transmitter specifications.

OM1200 Cellular Modem Frequency							
Antenna Gain and Collocated Radio Transmitter Specifications							
Note: The radiated power of a collocated transmitter must not exceed the EIRP limits stipulated in this table.							
	Operating mode	Tx Freq Range (MHz)		Max Time-Avg Cond. Power (dBm)	Antenna Gain Limit (dBi)		EIRP Limits (dBm)
					Standalone	Collocated	
EM7565 Embedded Module	WCDMA Band 2, LTE B2	1850	1910	24	6	4	30
	WCDMA Band 4 , LTE B4	1710	1755	24	6	4	30
	WCDMA Band 5 , LTE B5	824	849	24	6	4	30
	LTE B7	2500	2570	23.8 (a)	9	4	32.8
	LTE B12	699	716	24	6	4	30
	LTE B13	777	787	24	6	4	30
	LTE B26	814	849	24	6	4	30
	LTE B41	2496	2690	23.8 (a)	9	4	32.8
	LTE 848 (b)	3550	3700	23	0	0	23
	LTE B66	1710	1780	24	6	4	30
EU Band Support	WCDMA Band 1, LTE B1	1920	1980	24			24
	LTE B3	1710	1785	24			24
	LTE B7	2500	2570	23			24
	WCDMA band 8, LTE B8	880	915	24			24
	LTE B20	832	862	24			24
	LTE B28	703	748	24			24
Table Notes:							
(a) Includes 0.8 dB offset from single-cell tolerance for UL CA							
(b) Important. Airborne operations in LTE Band 48 are prohibited							
Additional Supported Bands Band 42 and 43 TDD							
NOTE: UMTS band III is disabled for this product							

OM2200 antenna gain and collocated radio transmitter specifications.

OM2200 Cellular Modem Frequency							
Antenna Gain and Collocated Radio Transmitter Specifications							
Note: The radiated power of a collocated transmitter must not exceed the EIRP limits stipulated in this table.							
	Operating mode	Tx Freq Range (MHz)		Max Time-Avg Cond. Power (dBm)	Antenna Gain Limit (dBi)		EIRP Limits (dBm)
					Standalone	Collocated	
EM7565 Embedded Module	WCDMA Band 2, LTE B2	1850	1910	24	6	4	30
	WCDMA Band 4 , LTE B4	1710	1755	24	6	4	30
	WCDMA Band 5 , LTE B5	824	849	24	6	4	30
	LTE B7	2500	2570	23.8 (a)	9	4	32.8
	LTE B12	699	716	24	6	4	30
	LTE B13	777	787	24	6	4	30
	LTE B26	814	849	24	6	4	30
	LTE B41	2496	2690	23.8 (a)	9	4	32.8
	LTE 848 (b)	3550	3700	23	0	0	23
	LTE B66	1710	1780	24	6	4	30
EU Band Support	WCDMA Band 1, LTE B1	1920	1980	24			24
	LTE B3	1710	1785	24			24
	LTE B7	2500	2570	23			24
	WCDMA band 8, LTE B8	880	915	24			24
	LTE B20	832	862	24			24
	LTE B28	703	748	24			24
Table Notes:							
(a) Includes 0.8 dB offset from single-cell tolerance for UL CA							
(b) Important. Airborne operations in LTE Band 48 are prohibited							
Additional Supported Bands Band 42 and 43 TDD							
NOTE: UMTS band III is disabled for this product							

Reset and Erase

[CONFIGURE > System > Reboot](#)

The Operations Manager reboots with all settings (e.g. the assigned network IP address) preserved.

To reboot the unit:

Select **CONFIGURE > System > Reboot**.

To erase the unit:

Push the **Erase** button on the port-side panel twice with a bent paper clip while the unit is powered on.

This resets the appliance to its factory default settings. Any modified configuration information is erased. You will be prompted to log in and must enter the default administration username and administration password (Username: root Password: default). You will be required to change this password during the first log in.

Initial Settings

This section provides step-by-step instructions for the initial settings on your Operations Manager.

By default, all interfaces are enabled. The unit can be managed via Web GUI or by command line interface (CLI).

- "Default Settings" on the next page
- "Management Console Connection via CLI" on page 31
- "Change the Root Password" on page 32
- "Disable a Root User" on page 34
- "Change Network Settings" on page 35
- For Configure Serial Ports (see "Configure Serial Ports" on page 50)

Tip: There is also a Quick Start Guide to assist with easy setup of the Operations Manager. The QSG is available at:
<https://opengear.com/support/documentation/>

Default Settings

Tip: See also the Quick Start Guide available at the Opengear documentation web page: <https://opengear.com/support/documentation/>

The Operations Manager comes configured with a default static IP Address for NET1 of 192.168.0.1 Subnet Mask 255.255.255.0.

Serial Port Settings

The default settings for the serial ports 1 up to 48 on a new device are:

“Console server” mode, 9600, 8N1, X2 (Cisco straight) pinout; the escape character is “~” .

Browser Web GUI

The Operations Manager offers a Web GUI via web browser that supports HTML5.

1. Type `https://192.168.0.1` in the address bar. HTTPS is enabled by default.
2. Enter the default username and password

Username: root

Password: default

3. After the first successful log-in you are required to change the root password.
4. After log-in the Web GUI is available. Check system details in the top right-hand side of the Web GUI.
5. In the Navigation Bar on the left side, navigate to the **ACCESS > Serial Ports** page. The Serial Ports page displays a list of all the serial devices, including

the links to a Web Terminal or SSH connection for each.

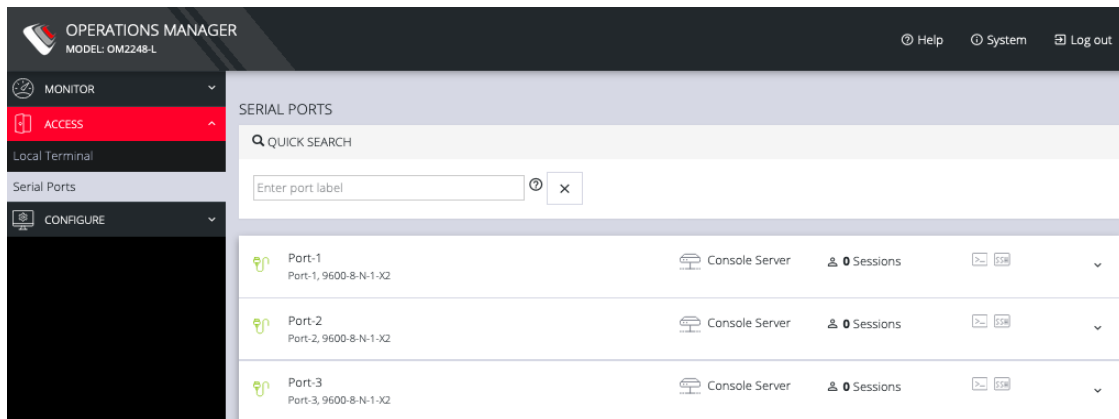

Using the Web GUI

The Web GUI can be switched between **Light** or **Dark** mode by adjusting the toggle on the bottom left.



Light mode changes the user interface to display mostly light colors. This is the default UI setting. Dark mode changes the user interface to display mostly dark colors, reducing the light emitted by device screens.

The Web GUI has three menu options on the upper right: **Help**, **System**, and **Log out**.

The **Help** menu contains a link to generate a **Technical Support Report** that can be used by OpenGear Support for troubleshooting. It also contains a link to the latest Operations Manager User Guide.

The System menu presents the **Current version**, **REST API version**, **Hostname**, **Serial Number**, **Model**, and **Current user**.

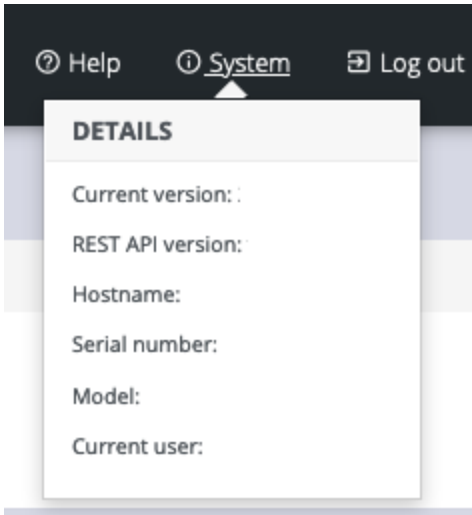

22.11.0	Initial Settings	30
---------	------------------	----

Management Console Connection via CLI

The Command Line Interface (CLI) is accessible using your preferred application to establish an SSH session. Open a CLI terminal on your desktop, then:

1. Input the default IP Address of 192.168.0.1. SSH port 22 is enabled by default.
2. When prompted, enter the log in and password in the CLI.
3. After a successful log in, you'll see a command prompt.

Accessing the Web GUI CLI Terminal

An alternative CLI terminal is provided within the Web GUI. To access this terminal, in the left-hand side **Navigation Bar**, navigate to the **ACCESS > Local Terminal** page. You will be required to submit your log-in credentials.

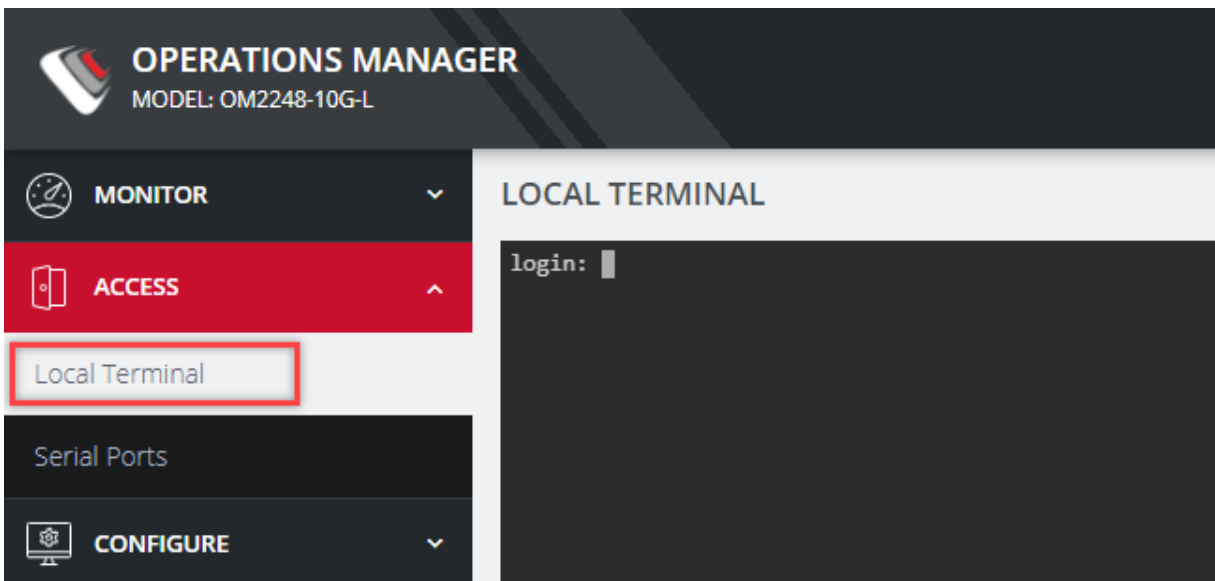

22.11.0	Initial Settings	31
---------	------------------	----

Change the Root Password

[CONFIGURE](#) > [User Management](#) > [Local Users](#) > [Edit User](#)

For security reasons, only the root user can initially log in to the appliance. Upon initial login the default password must be changed.

Tip: Other Users' passwords may be changed using the same procedure by selecting the User's account name under the **Username** heading.

Note: The password must comply with your company's password complexity policy. See "[Local Password Policy](#)" on page 145

To change the password at any time:

1. Navigate to **CONFIGURE** > **User Management** > **Local Users**
2. Click the Root user's **Edit User** icon below the **Actions** heading.

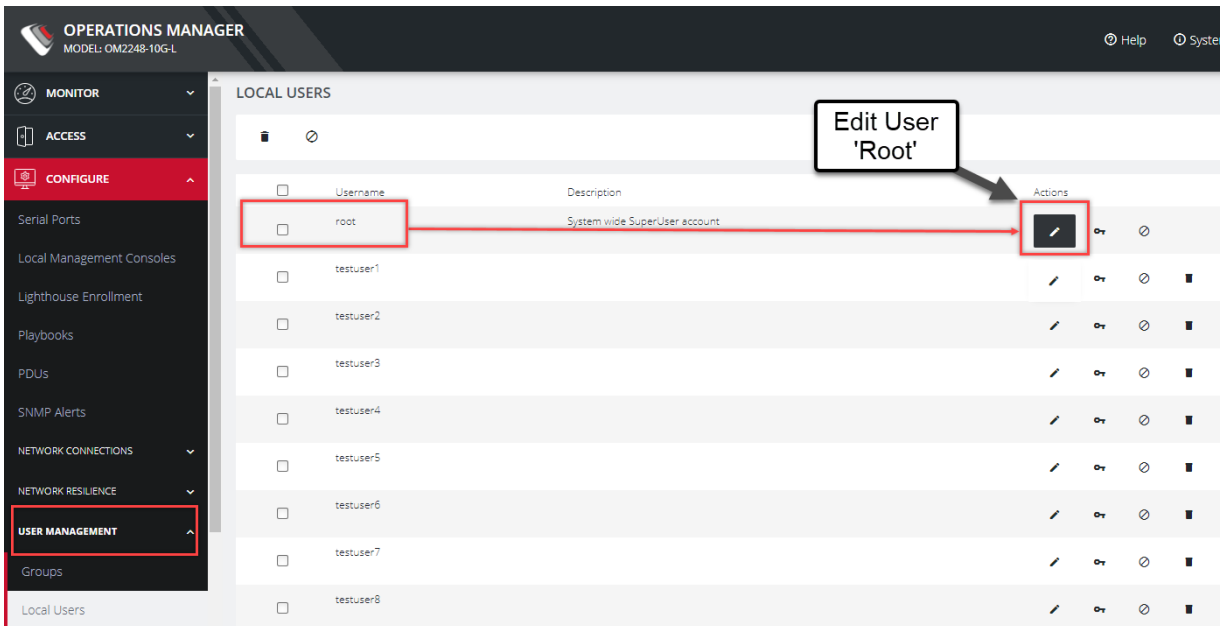

The screenshot shows the 'LOCAL USERS' page in the OpenGear Operations Manager. The left sidebar has 'CONFIGURE' selected, and 'USER MANAGEMENT' is expanded to show 'Local Users'. The main content area displays a table of users. The 'root' user is highlighted with a red box, and the 'Edit User' icon (a pencil) in the 'Actions' column is also highlighted with a red box and labeled 'Edit User 'Root''.

Username	Description	Actions
root	System wide SuperUser account	[Edit] [Delete] [Refresh] [More]
testuser1		[Edit] [Delete] [Refresh] [More]
testuser2		[Edit] [Delete] [Refresh] [More]
testuser3		[Edit] [Delete] [Refresh] [More]
testuser4		[Edit] [Delete] [Refresh] [More]
testuser5		[Edit] [Delete] [Refresh] [More]
testuser6		[Edit] [Delete] [Refresh] [More]
testuser7		[Edit] [Delete] [Refresh] [More]
testuser8		[Edit] [Delete] [Refresh] [More]

3. In the **Edit User** page, if required, enter an optional description in the **Description** field. Enter a new password in the **Password** field and re-enter the password in the **Confirm Password** field.

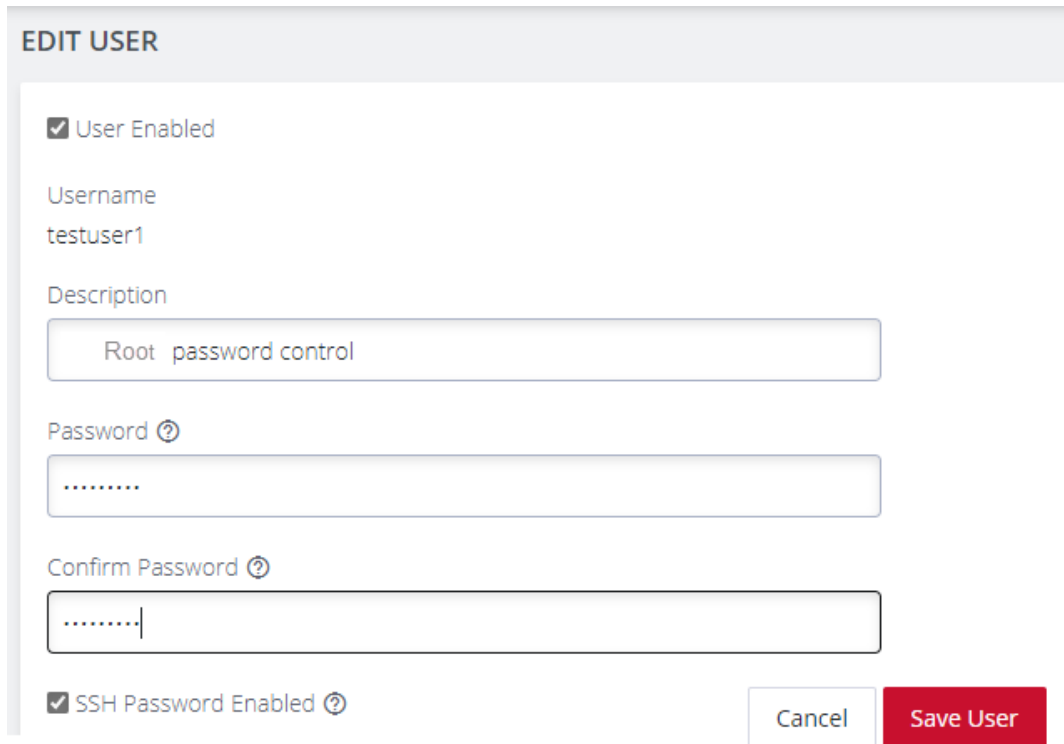

EDIT USER

User Enabled

Username
testuser1

Description
Root password control

Password ⓘ
.....

Confirm Password ⓘ
.....

SSH Password Enabled ⓘ

Cancel Save User

4. Click **Save User**. A green banner confirms the password change has been saved.

Disable a Root User

[CONFIGURE > User management > Local Users](#)

To disable a root user:

Note: Before proceeding, make sure that another user exists that has the Administrator role or is in a group with the Administrator role. For information on creating, editing, and deleting users, see "[Local Users](#)" on page 134

1. Navigate to **CONFIGURE > User management > Local Users**
2. Click the **Disable User** button in the **Actions** section next to the root user.
3. Click **Yes** in the **Confirmation** dialog.

To enable root user, log in with another user that has the Administrator role and click the **Enable User** button in the **Actions** section next to the root user.

Change Network Settings

[CONFIGURE](#) > [Network Connections](#) > [Network Interfaces](#)

The interface supports both IPv4 and IPv6 networks. The IP address of the unit can be setup for Static or DHCP. The following settings can be configured for network ports:

- IPv4, IPv6
- Static and/or DHCP
- Enabling or disabling network interfaces
- Ethernet Media types

To add a new connection:

1. Click **CONFIGURE** > **Network Connections** > **Network Interfaces**

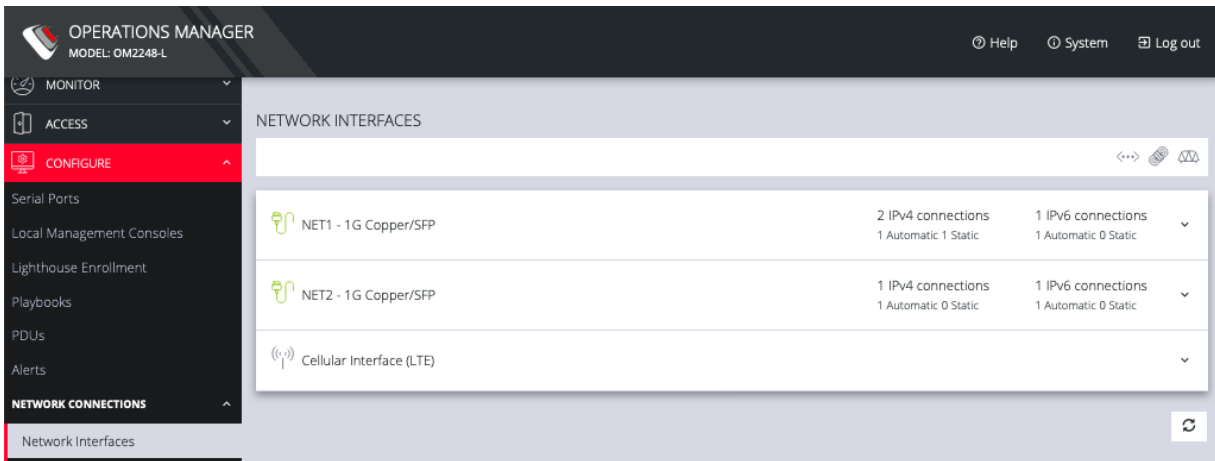

2. Click the **expand arrow** to the right of the desired interface to view its details.
3. Click the **plus icon** to open the **New Connection** page.

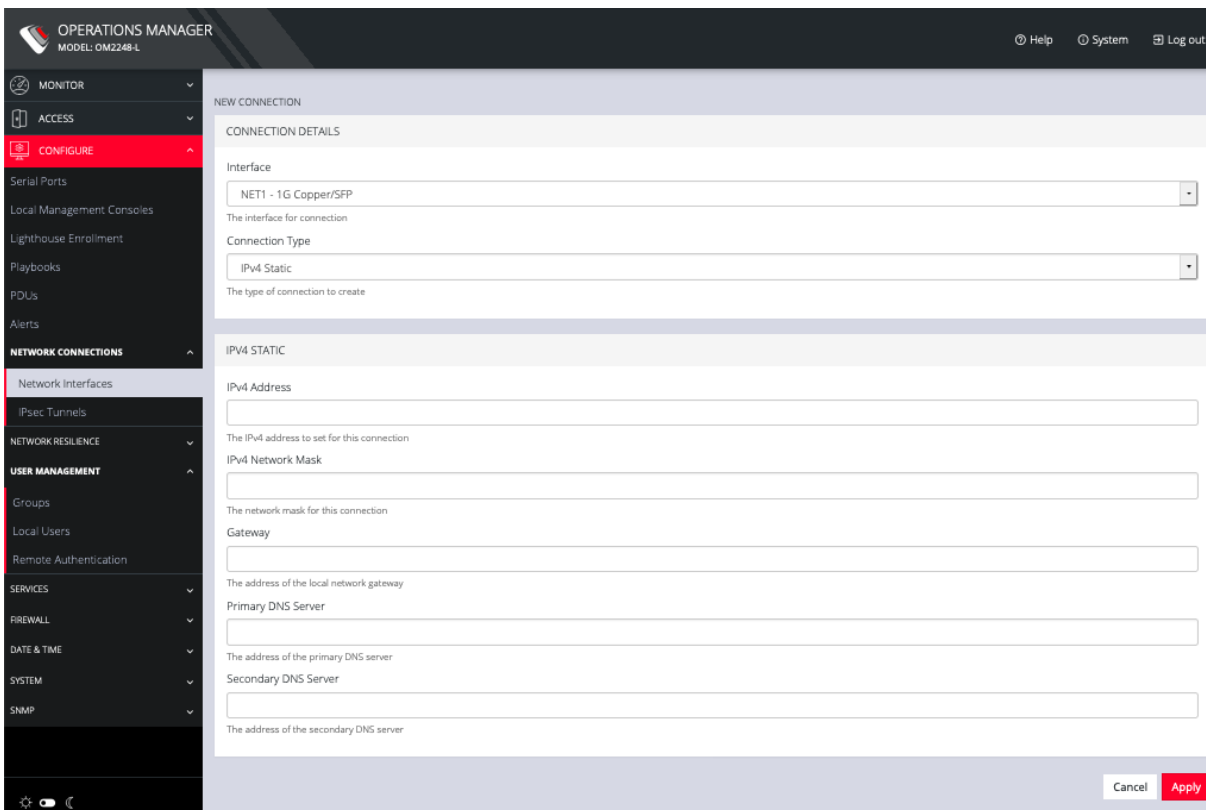

4. Select the **Interface** and **Connection Type** for your new connection.
5. The form on the bottom part of the page will change based on the **Connection Type** you choose. Enter the necessary information and click **Apply**.

To disable or delete interfaces, use the controls on the expanded section on the **CONFIGURE > Network Connections > Network Interfaces** page.

Note: If you experience packet loss or poor network performance with the default auto-negotiation setting, try changing the Ethernet Media settings on the Operations Manager and the device it is connected to. In most cases, select 100 megabits, full duplex. Make sure both sides are set identically.

To change the Ethernet Media Type:

22.11.0	Initial Settings	36
---------	------------------	----

1. Click **CONFIGURE** > **Network Connections** > **Network Interfaces**

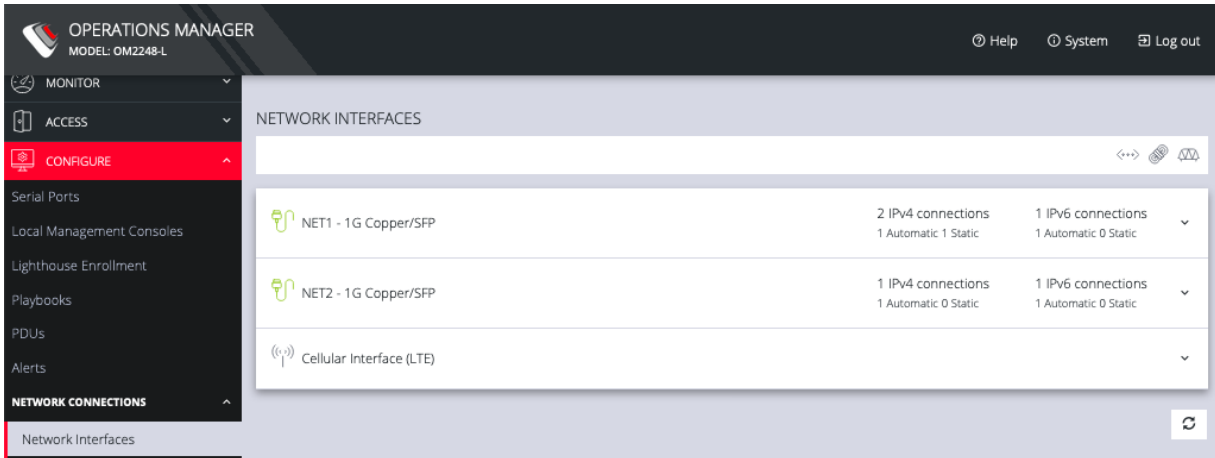

2. Click the expand arrow to the right of the interface you wish to modify.

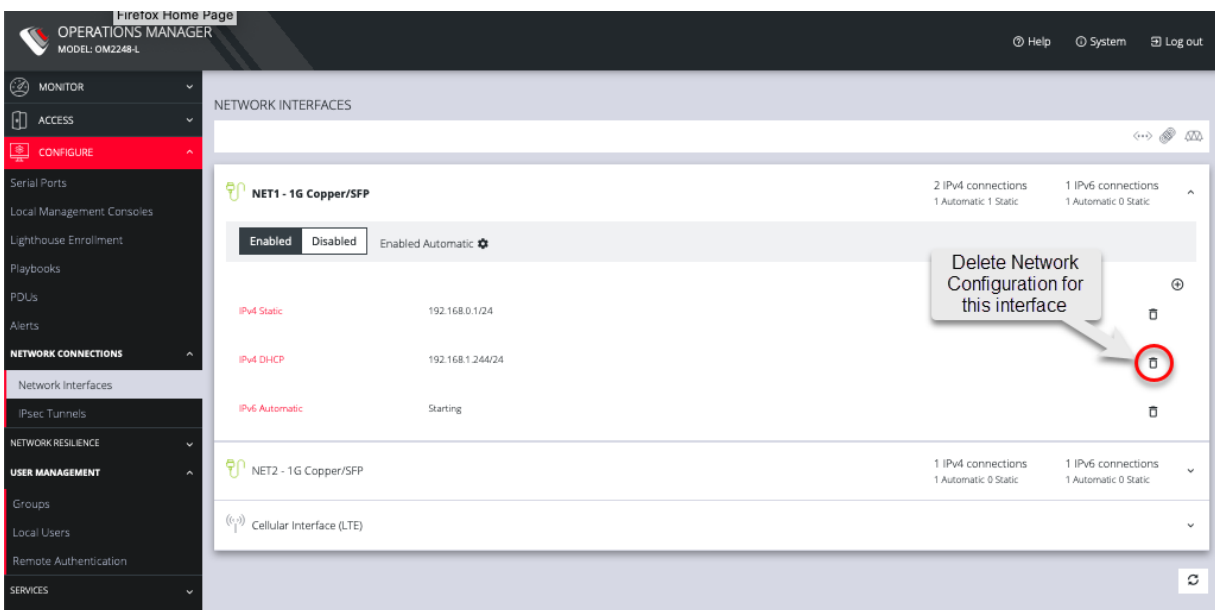

3. Click **Enabled** .

4. To change the interface media setting, click the **Edit** button and edit the media settings as needed and click **Apply**.

EDIT NET1 - 1G COPPER/SFP

Interface Enabled

Media (Copper only) [?](#)

Automatic ▾

- Automatic
- 10M Half Duplex
- 10M Full Duplex
- 100M Half Duplex
- 100M Full Duplex
- 1000M Half Duplex
- 1000M Full Duplex

Name Server [?](#)

No name servers have been set

[+ Add Name Server](#)

Search Domain [?](#)

No search domains have been set

[+ Add Search Domain](#)

Cancel

Apply

MONITOR Menu

The MONITOR Menu is a relatively short section comprising only three topics.

- System Log
 - Details of the system activity log, access and communications events with the server and with attached serial, network and power devices.
- LLDP/CDP Neighbors
 - Details of the LLDP/CDP Neighbors that are displayed when enabled for a connection.
- Triggered Playbooks
 - Monitoring current **Playbooks**, and applying filters to view any Playbooks that have been triggered.

System Log

[MONITOR > System Log](#)

The Operations Manager maintains a log of system activity, access and communications events with the server and with attached serial, network and power devices.

To view the System Log, click **MONITOR > System Log**.

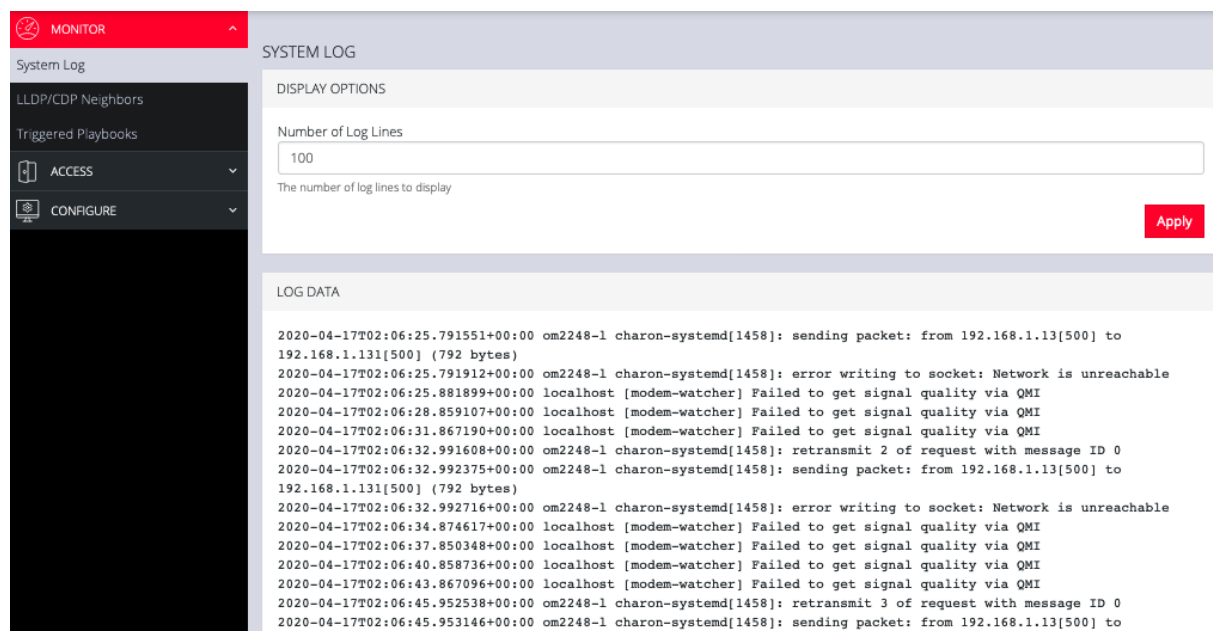

The screenshot shows the 'MONITOR' tab selected in a red header. Below it, a sidebar contains navigation options: 'System Log' (selected), 'LLDP/CDP Neighbors', 'Triggered Playbooks', 'ACCESS', and 'CONFIGURE'. The main content area is titled 'SYSTEM LOG' and features a 'DISPLAY OPTIONS' section with a 'Number of Log Lines' input field set to '100' and an 'Apply' button. Below this is the 'LOG DATA' section, which displays a list of system log entries. The entries include timestamps, IP addresses, and messages such as 'sending packet: from 192.168.1.13[500] to 192.168.1.131[500] (792 bytes)', 'error writing to socket: Network is unreachable', and 'Failed to get signal quality via QMI'.

The System Log page lets you change the Number of Log Lines displayed on the screen. The newest items appear on the bottom of the list. Click the **Refresh** button on the bottom right to see the latest entries.

LLDP CDP Neighbors

MONITOR > LLDP/CDP Neighbors

The Operations Manager displays LLDP/CDP Neighbors when enabled for a connection. See **CONFIGURE > SERVICES > Network Discovery Protocols** to enable/disable.

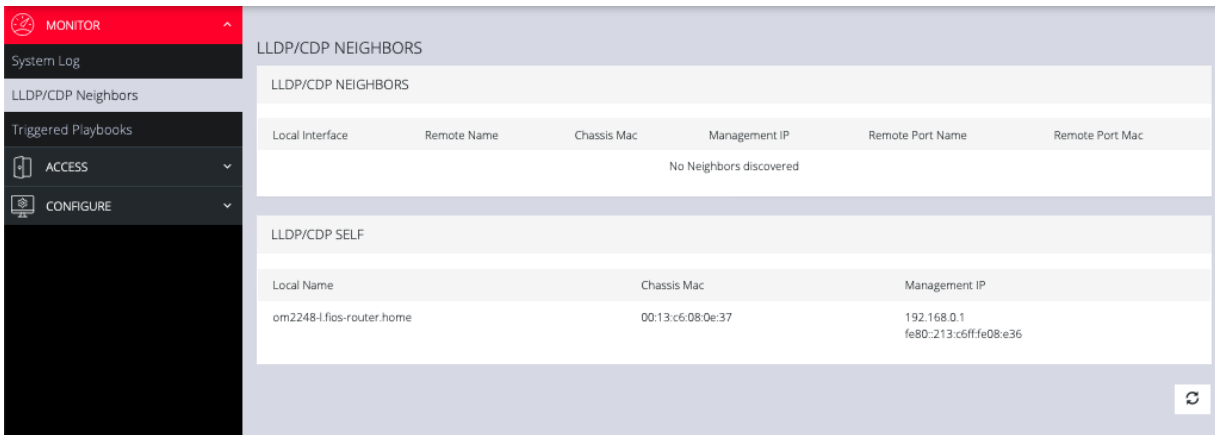

The screenshot shows the 'MONITOR' menu on the left with 'LLDP/CDP Neighbors' selected. The main content area is titled 'LLDP/CDP NEIGHBORS' and contains two tables.

LLDP/CDP NEIGHBORS Table:

Local Interface	Remote Name	Chassis Mac	Management IP	Remote Port Name	Remote Port Mac
No Neighbors discovered					

LLDP/CDP SELF Table:

Local Name	Chassis Mac	Management IP
om2248-l-fios-router.home	00:13:c6:08:0e:37	192.168.0.1 fe80::213:c6:ff:fe08:e36

Triggered Playbooks

[MONITOR > Triggered Playbooks](#)

For information on creating **Playbooks**, see the [Playbooks](#) topic in this User Guide.

To monitor current **Playbooks**, click on **Monitor > Triggered Playbooks**. Choose the time period if desired, and filter by **Name** of **Playlist** to view any that have been triggered.

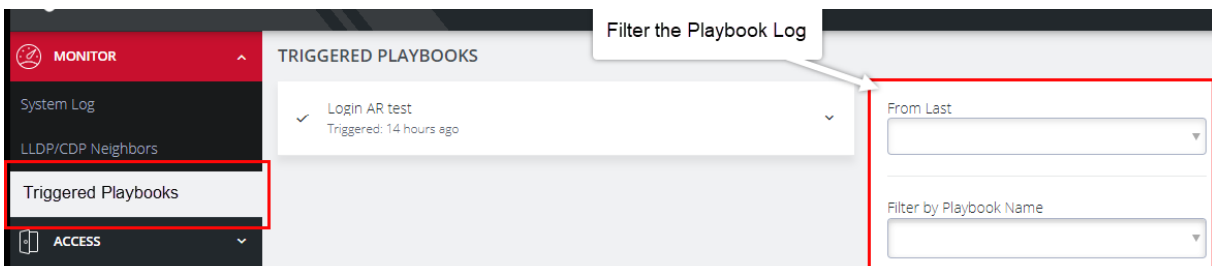



ACCESS Menu

The ACCESS menu lets you access the Operations Manager via a built-in Web Terminal. It also provides SSH and Web Terminal access to specific ports.

22.11.0	ACCESS Menu	43
---------	-------------	----

Local Terminal

[ACCESS > Local Terminal](#)

The Operations Manager includes a web-based terminal. To access this bash shell instance:

1. Select **ACCESS > Local Terminal**

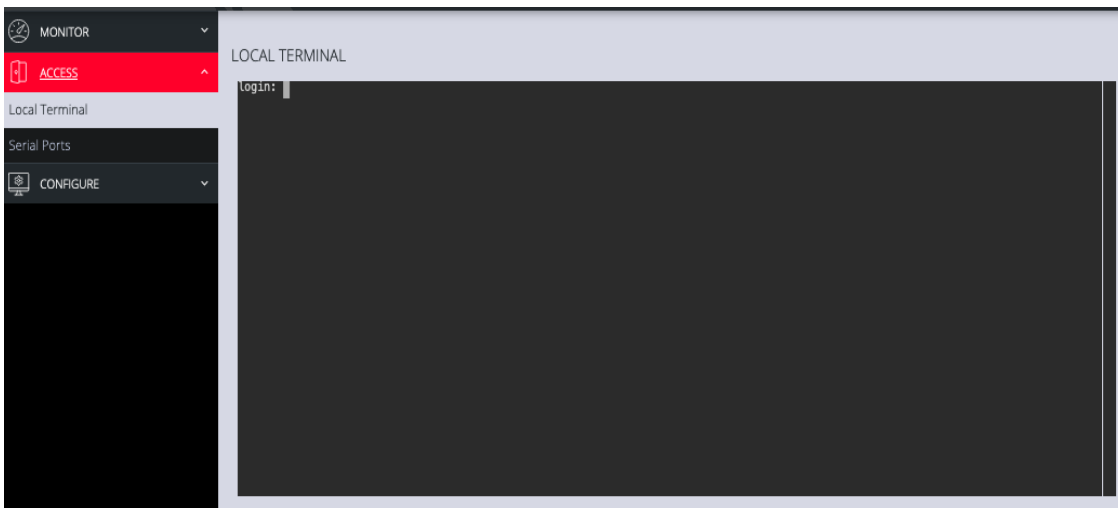

2. At the login prompt, enter a username and password.
3. A bash shell prompt appears.

This shell supports most standard bash commands and also supports copy-and-paste to and from the terminal.

To close a terminal session, close the tab, or type exit in the Web Terminal window. The session will timeout after 60 seconds.

Tip: The default for the CLI session timeout is “never” (value of 0), however, the Web session timeout defaults to 20min. The web session time-out will kill the CLI session even though the CLI session itself is set to “never”.

Access Serial Ports

[ACCESS > Serial Ports](#)

Tip: Ensure you are on the **ACCESS > Serial Ports** page and not the similar **CONFIGURE > Serial Ports** page.

The **ACCESS > Serial Ports** page allows you to quickly locate and access specific ports via Web Terminal or SSH link shown in the image below.

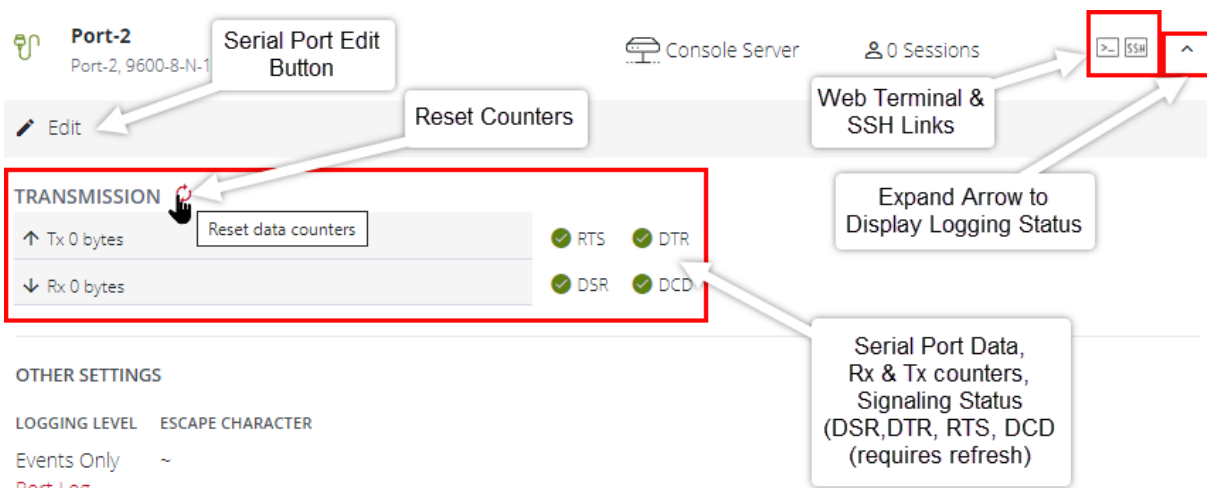

Click the **Expand arrow** to the right of the port to see the Port Logging status or access the port **Edit** button, which is a link to the **CONFIGURE > Serial Ports** page. (ogcli: `ogcli get ports/ports_status`).

The following information is displayed under **Access > Serial Ports** when the individual serial ports are expanded:

- Rx byte counter (counter reset requires 'Admin' or 'port config' rights)
- Tx byte counter (counter reset requires 'Admin' or 'port config' rights)
- Signaling information (DSR, DTR, CTS (see tip), RTS and DCD)

Tip: CTS information is not displayed in the UI but is available via the `ogcli query ogcli get ports/ports_status`.

- Logging information.

Quick Search

To find a specific port by its port label, use the **Quick Search** form at the top-right of the **ACCESS > Serial Ports** page.

Ports have default numbered labels. You can edit the port label for a given serial port under **CONFIGURE > Serial Ports**. Click the **Edit** button to open the **EDIT SERIAL PORT** page.

Access Using Web Terminal or SSH

To access the console port via the Web Terminal or SSH:

1. Locate the particular port on the **ACCESS > Serial Ports** page and click the expand arrow.
2. Click the **Web Terminal** or SSH link for the particular port.
 - Choosing **Web Terminal** opens a new browser tab with the terminal.
 - Choosing **SSH** opens an application you have previously associated with SSH connections from your browser.

Note: MS Windows does not connect to puTTY by default. You may need to install the WinSCP program to launch puTTY from the Opengear WebGUI SSH Serial Port button.

Serial Port Logging

The port logging facility and severity associated with the serial port logs is controlled and set at the **Configure > Services > Syslog > Global Serial Port Settings** page.

There is a separate setting to enable sending of serial port logs to remote side.

Note: Serial port logging is disabled by default. The logging level for each serial port is set at Logging Settings in **Configure > Serial Ports > Edit** .

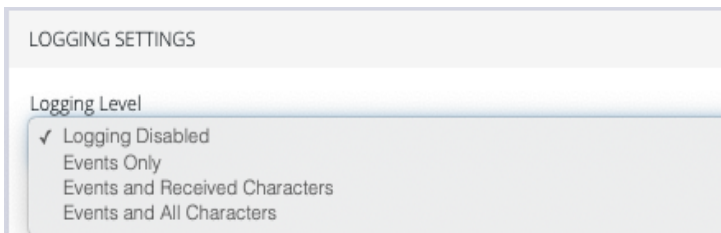

LOGGING SETTINGS

Logging Level

- Logging Disabled
- Events Only
- Events and Received Characters
- Events and All Characters

Display Port Logs

Tip: The log is accessed by clicking the **Port Log** link on the **ACCESS > Serial Ports** page. The link is only available when port logging is enabled.

 **Port-1**
Port-1, 9600-8-N-1-X2

 Edit

LOGGING LEVEL ESCAPE CHARACTER

Events Only ~ **Port Log Link**
Port Log



CONFIGURE Menu

This section provides step-by-step instructions for the menu items under the CONFIGURE menu.

22.11.0	CONFIGURE Menu	49
---------	----------------	----

Configure Serial Ports

[CONFIGURE > Serial Ports](#)

Tip: Ensure you are on the **CONFIGURE > Serial Ports** page and not the similar **ACCESS > Serial Ports** page.

Navigate to **CONFIGURE > Serial Ports**; a list of serial ports is displayed. On this page you can configure and edit specific ports. Click the **Edit** button (pencil icon) to the right of the port to display the port editing page.

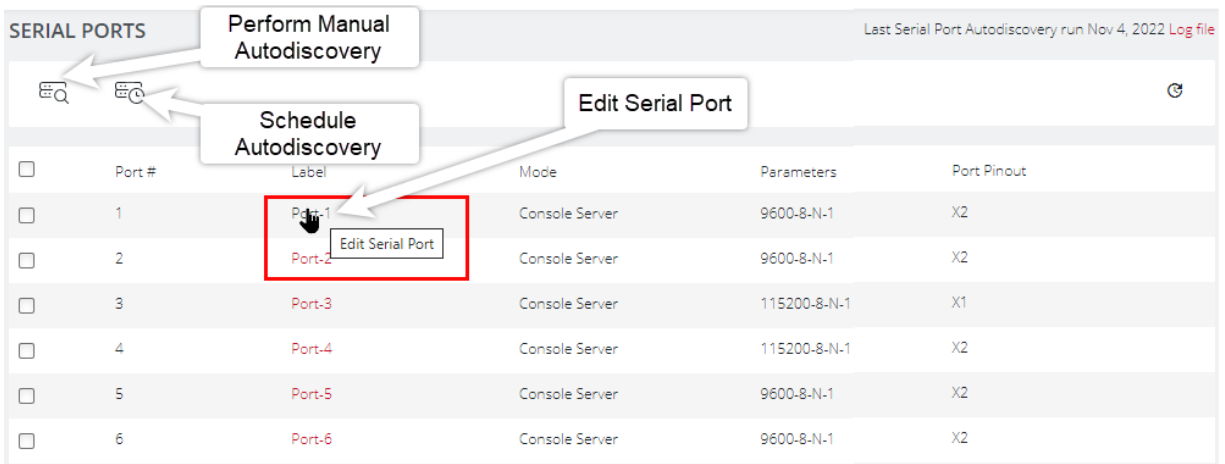

Perform Manual Autodiscovery

Schedule Autodiscovery

Edit Serial Port

Port #	Label	Mode	Parameters	Port Pinout
1	Port-1	Console Server	9600-8-N-1	X2
2	Port-2	Console Server	9600-8-N-1	X2
3	Port-3	Console Server	115200-8-N-1	X1
4	Port-4	Console Server	115200-8-N-1	X2
5	Port-5	Console Server	9600-8-N-1	X2
6	Port-6	Console Server	9600-8-N-1	X2

Edit Serial Ports

From the **Configure > Serial Ports** page, click the **Port label** text in the Label column. The **Edit Serial Port** page is displayed.

Edit Serial Port Properties		
Field	Options	Definition
Label	Default or Custom	The serial port unique identifier. This can be used to locate this port using the Quick Search form on the ACCESS > Serial Ports page.
Mode	Disabled Console Server Local Console	Console Server mode allows access to a downstream device via its serial port. Local Console mode allows access to the OM device's console through a serial port.
Port Pinout	Cisco Rolled Cisco Straight	Select pin-out type depending on the type of device or host to be connected via the port.
Baud Rate	Baud rate	Select the Baud rate expected for this port. From 50 to 230,400 bps.
Data Bits	Integer	The data bit length for character.
Parity	None, Odd, Even, Mark, Space.	The parity type for character.
Stop Bits	1, 1.5, 2	The Stop bit length used in character.
Escape Character	~	The character used for sending OOB Shell commands.

LOGGING SETTINGS		
Logging Level	Disabled Events Only Events & Received Characters Events & All Characters	Specify the level of detail you require in the logs. Logs may also be sent to a Syslog server. Other settings to consider are: GLOBAL SERIAL PORT SETTINGS” under Services > <i>Remote Syslog</i> in this User Guide. “Send Serial Port Logs” under Services > Syslog > Edit Syslog Server
PORT IP ALIASES		
IP Address	Alias IP Address and interface type.	Allocate an IP address for dedicated access to a specific serial port.

Assigning unique IP addresses for each console port

Note: For further information about assigning unique IP addresses for each console port see the Zendesk article [Assigning Unique IP Addresses For Each Console Port](#) .

Autodiscovery

The Autodiscovery feature attempts to discover the host name of connected devices, this uses the hostname of the device used to set the port label, so as to set it as the port label of each serial port. This can save the need to manually provide hostnames during setup.

Autodiscovery will attempt to discover port settings even if the hostname discovery fails. The first discovery run uses currently configured port settings such as the current baud rate, etc. Thereafter, it will fetch or use a single set of pre-configured credentials to login and discover the hostname from e.g. the OS prompt, for devices that do not display hostname pre-authentication.

Syslogging enhancement assists in the diagnosis of common issues (for example, no comms or, hostname failed validation). Autodiscovery does not collect a hostname when there is a communication issue between the console server and the target device. The logs are saved for the last-run instance of autodiscovery.

The UI displays error messages and logs with the reason for auto-discovery failure, for example:

- Authentication failed.
- Communication issue with the target device.
- Password to renew before being able to authenticate to the target device.
- Abnormal characters or strings detected.

Autodiscovery has been enhanced to discover baud rate and pinout (X1 / X2). The UI has been updated to indicate if ports are scheduled for discovery.

Note: The OM1208 will only discover X2 connections.

The **Serial Ports** page also allows you perform an Autodiscovery on selected ports. Autodiscovery of console ports attempts to set the port label by setting the baud rate to various rates (in the following order): 9600, 115200, 38400, 19200, and 57600.

Tip: Autodiscovery on other Baud rates may be done by manually running the `port_discovery` script from the Web Terminal.

Autodiscovery may be done manually by clicking **Perform Autodiscovery**.

Autodiscovery Enhancements

From the 22.11 release, the following parameter enhancements have been added to the `port_discovery` script which can be configured via the REST API or CLI:

- `--username` and `--password`
- `--apply-config` and `--no-apply-config`
- `--auth-timeout`
- `--hostname-pattern`

The `--username` and `--password` options can also be configured via the UI under *Optional Credentials*.

If the values are provided (optional), they will be used to attempt login to obtain the hostname to a downstream serial device. You can only specify a single username and/or password to try on all devices.

Optional Credentials ⓘ

Cancel Autodiscovery

Port Autodiscovery may be cancelled *while running* by clicking on the **Cancel** button at the top-right of the Serial Ports window of the UI.

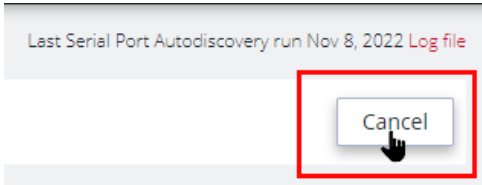

Schedule Autodiscovery

Autodiscovery can be scheduled periodically as required by clicking the **Schedule Autodiscovery** button in the **Serial Ports** window.

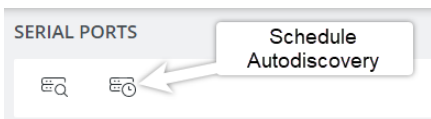

The **Schedule Autodiscovery** window allows you to select the ports and specify a time and period for port detection to run. Activate the schedule by clicking on the **Enabled** button.

The Serial Port Autodiscovery Page:

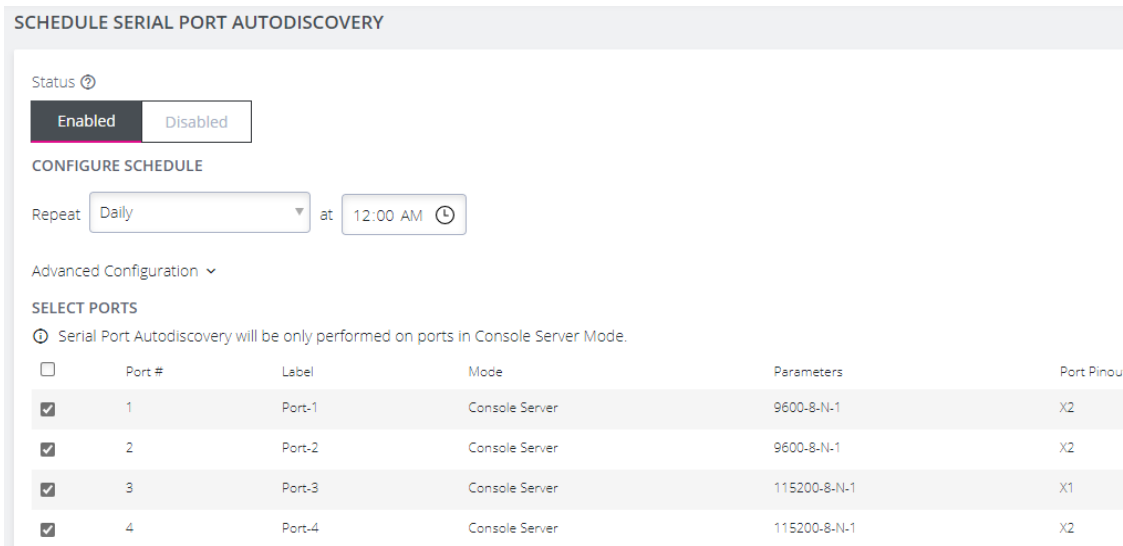

A screenshot of the "SCHEDULE SERIAL PORT AUTODISCOVERY" page. The page has a header "SCHEDULE SERIAL PORT AUTODISCOVERY". Below the header, there is a "Status" section with "Enabled" and "Disabled" buttons. The "Enabled" button is selected. Below this is a "CONFIGURE SCHEDULE" section with a "Repeat" dropdown set to "Daily" and a time selector set to "12:00 AM". There is also an "Advanced Configuration" dropdown. Below that is a "SELECT PORTS" section with a note: "Serial Port Autodiscovery will be only performed on ports in Console Server Mode." Below this is a table with columns: Port #, Label, Mode, Parameters, and Port Pinout. The table has four rows, all with checkboxes checked.

Port #	Label	Mode	Parameters	Port Pinout	
<input checked="" type="checkbox"/>	1	Port-1	Console Server	9600-8-N-1	X2
<input checked="" type="checkbox"/>	2	Port-2	Console Server	9600-8-N-1	X2
<input checked="" type="checkbox"/>	3	Port-3	Console Server	115200-8-N-1	X1
<input checked="" type="checkbox"/>	4	Port-4	Console Server	115200-8-N-1	X2

Retrieve Port Discovery Logs

At the top-right of the UI window, click on the **Log File** red text to retrieve the port discovery logs or by clicking on the **View Logs** red text in the **autodiscovery running** banner.

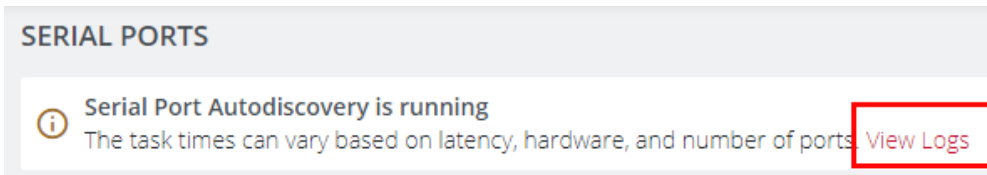
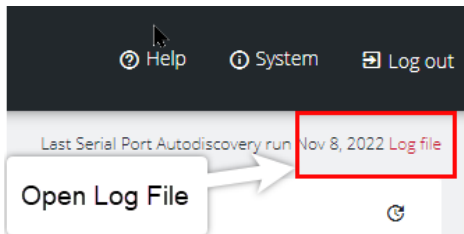

Port Discovery Log File Example:

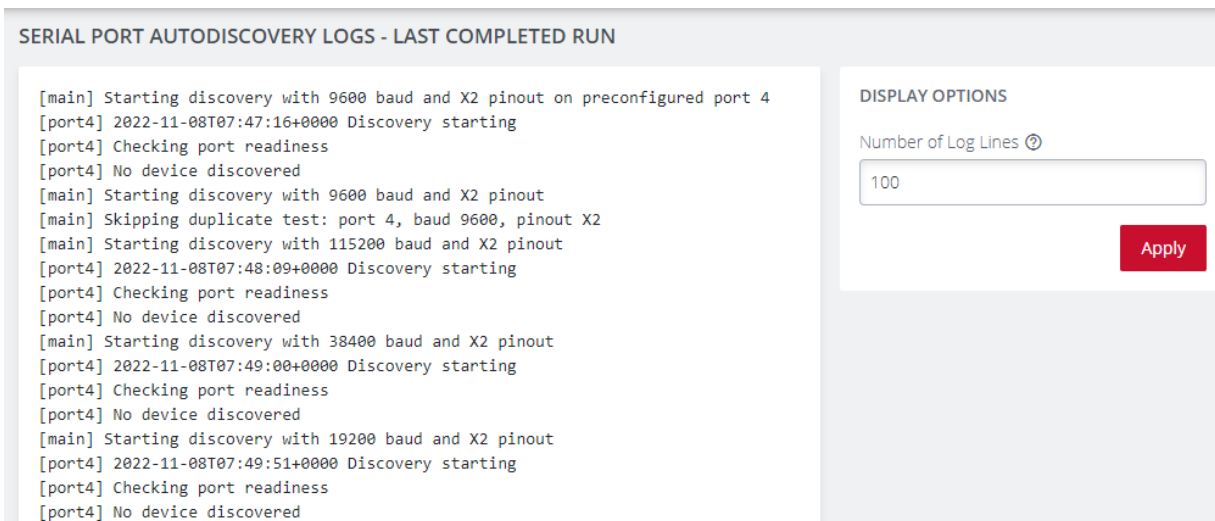

Local Management Consoles

Note: Applies to OM2200 Devices only. Not applicable to OM1200.

[CONFIGURE > Local Management Consoles](#)

This feature allows administrators to log in and configure the OM via the RJ-45 or USB ports on the device. You can edit settings or disable the local RJ45 serial console (Cisco straight -X2 pinout) and the USB serial console (needs user supplied micro-USB to USB-A cable).

To edit the settings of a local management console:

1. Navigate to **CONFIGURE > Local Management Consoles**. Here you'll see a list of consoles.
2. Locate the console you want to manage, then, click on the **Edit Management Console Port** button (pencil icon) under **Actions**.
3. On the **Edit Local Management Console** page you can set the parameters for:
 - **Baud Rate**
 - **Data Bits**
 - **Parity**
 - **Stop Bits**
 - **Terminal Emulation**
 - Enable or disable **Kernel Debug Messages**
 - Enable or disable the selected **Management Console**

Note: Enabling **Kernel Debug Messages** can only be applied to a single serial management console.

To disable a local management console:

1. Click **CONFIGURE > Local Management Consoles**.
2. Click on the **Disable Management Console Port** button under **Actions** next to the console you wish to disable.



Lighthouse Enrollment

[CONFIGURE > Lighthouse Enrollment](#)

Opengear appliances can be enrolled into a Lighthouse instance, providing centralized access to console ports, NetOps Automation, and central configuration of Opengear devices.

Lighthouse central management uses a persistent, public key authenticated SSH tunnels to maintain connectivity to managed console servers.

All network communications between Lighthouse and each console server (e.g. access to the web UI), and the console server's managed devices (e.g. the serial consoles of network equipment), is tunneled through this SSH management tunnel.

The below Zendesk articles and user guide contain further information about Lighthouse Enrollment:

[Manual enrollment using UI or CLI](#)

[How do I add Nodes to Lighthouse](#)

[Lighthouse User Guide](#)

22.11.0	CONFIGURE Menu	59
---------	----------------	----

Manual Enrollment Using UI

Note: To enroll your Operations Manager to a Lighthouse instance, you must have Lighthouse installed and have an enrollment token set in Lighthouse.

1. In Lighthouse. Set an OM enrollment token, click on **CONFIGURE > NODE ENROLLMENT > Enrollment Settings** page, and enter an **Enrollment Token**.

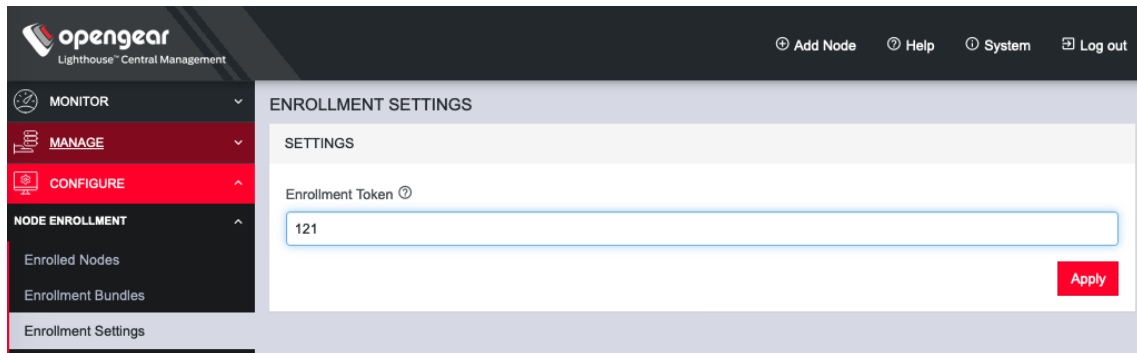

Tip: The same token will be entered in the **NEW LIGHTHOUSE ENROLLMENT** page of the Operations Manager.

2. Enroll your Operations Manager in this Lighthouse instance:
Click **CONFIGURE > Lighthouse Enrollment**
3. Click on the **Add Lighthouse Enrollment** button on the top-right of the page.
The **New Lighthouse Enrollment** page opens.

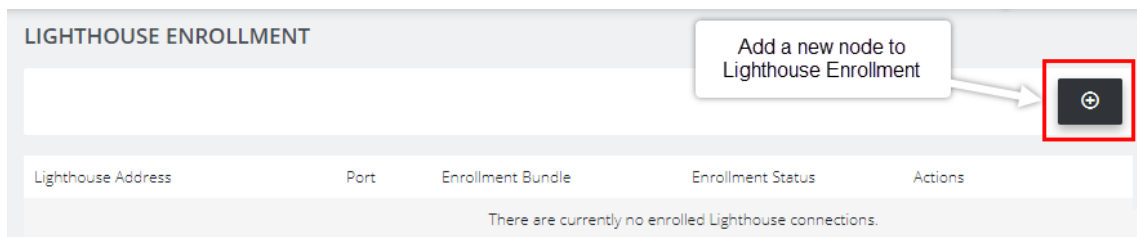

4. Enter the IP address or fully qualified domain name of the Lighthouse instance and the **Enrollment Token** you created in Lighthouse. Optionally enter a **Port** and an **Enrollment Bundle** (see the [Lighthouse User Guide](#) for more information about Bundling).

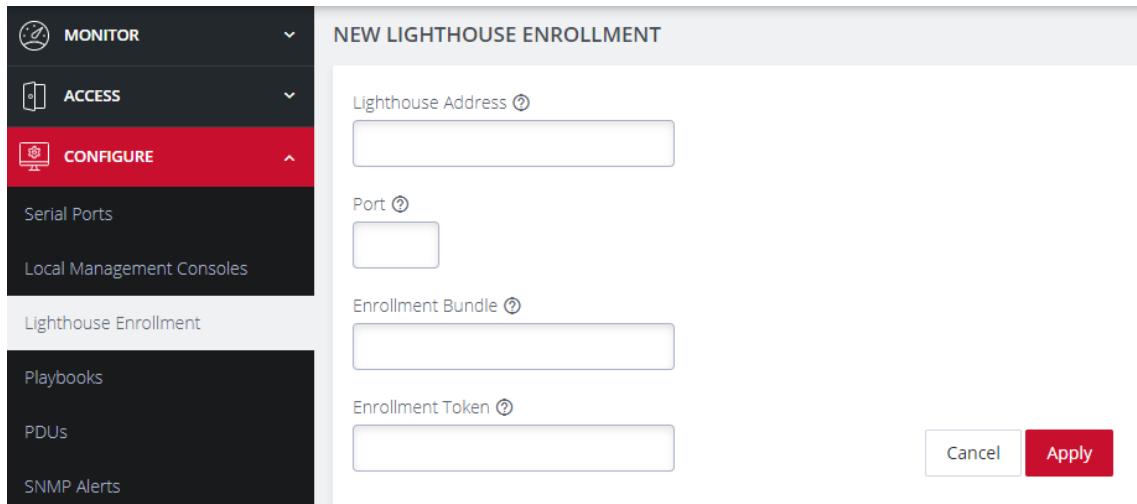

The screenshot shows the 'NEW LIGHTHOUSE ENROLLMENT' form in the Lighthouse web interface. The left sidebar is visible with the 'CONFIGURE' menu item highlighted. The main content area contains four input fields: 'Lighthouse Address', 'Port', 'Enrollment Bundle', and 'Enrollment Token'. Each field has a help icon (question mark in a circle). At the bottom right of the form, there are two buttons: 'Cancel' and 'Apply'.

5. Click the **Apply** button. A flag will confirm the enrollment.

Note: Enrollment can also be done directly via Lighthouse using the Add Node function. See the Lighthouse User Guide for more instructions on enrolling Opengear devices into Lighthouse.

Manual Enrollment Using the CLI

For complete instructions on Lighthouse Enrollment via the CLI please refer to this link: [Manual enrollment using UI or CLI](#).

Playbooks

[CONFIGURE > Playbooks](#)

Playbooks are configurable systems that periodically check if a user-defined **Trigger** condition has been met. Playbooks can be configured to perform one or more specified **Reactions** when a specific trigger event occurs.

The Playbook Landing Page:

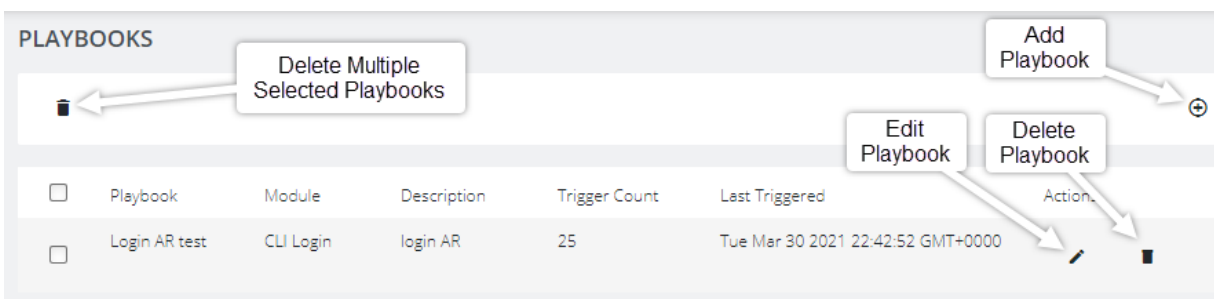

Create Or Edit a Playbook

[CONFIGURE > Playbooks > Add Playbook](#)

To create a new Playbook:

Navigate to the **Configure > Playbooks** page.

Click the **Add Playbook** button (top-right) to create a new **Playbook**. The **Edit Playbook** page is displayed. Complete the required Playbook setup information as detailed in the following procedures.

TRIGGER Section:

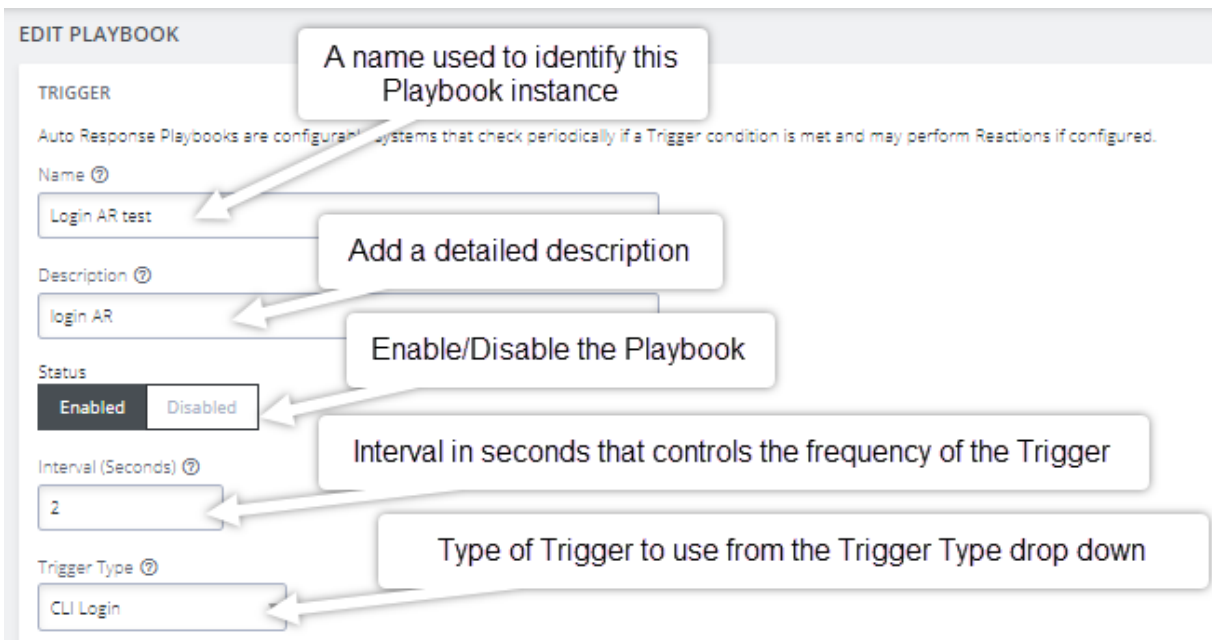

EDIT PLAYBOOK

TRIGGER

Auto Response Playbooks are configurable systems that check periodically if a Trigger condition is met and may perform Reactions if configured.

Name ⓘ
Login AR test

Description ⓘ
login AR

Status
 Enabled Disabled

Interval (Seconds) ⓘ
2

Trigger Type ⓘ
CLI Login

Callouts:
- A name used to identify this Playbook instance (points to Name)
- Add a detailed description (points to Description)
- Enable/Disable the Playbook (points to Status)
- Interval in seconds that controls the frequency of the Trigger (points to Interval)
- Type of Trigger to use from the Trigger Type drop down (points to Trigger Type)

1. Enter a unique **Name** for the **Playbook** that reflects its purpose.
2. Add a detailed **Description** that will help others to understand what it does.
3. Select **Enabled** to activate the **Playbook** after you have created it.
4. Enter an **Interval** in seconds to control the frequency that the **Trigger** will be checked.
5. Choose the type of **Trigger** to use from the **Trigger Type** drop down.

Tip: See the Trigger Type table on the following page for additional trigger type information.

Trigger Types:

Trigger	Reaction Description
CLI Login	Triggers upon Login or Logout events. Select either or both.
CLI Login Failure	Monitor the terminal and trigger on failed user login attempts.
Cell Connection	Triggered whenever the cellular connection state changes. This Trigger type is only compatible with cellular units.
Cell Message	Triggered when an SMS message that matches the user-defined message pattern. Cellular units only.
Cell Signal Strength	Triggered if the cellular signal strength moves below a user-defined percentage.
Curl	Periodically attempts to perform a HTTP request using curl and triggers the Playbook reaction based on the results.
Custom Command	Periodically runs a custom Shell command and triggers the Playbook reaction upon failure.
Load	Monitors the system load average and triggers the Playbook if it breaches the user-defined acceptable range.
Memory Usage	Triggered if the system memory usage exceeds the user-defined percentage threshold.
Network Settings	Monitors network interfaces for specific attributes and triggers a user-defined response when they change.
Ping	Periodically pings an address and triggers a user-defined response upon failure.

Continued...

Trigger	Description
Serial Login	Monitors selected serial ports and triggers a user-defined reaction upon user login and logout events.
Serial Pattern	Monitors serial ports and triggers a reaction when data matching a pattern is received on specific ports.
Serial Signal	Monitors selected serial ports and triggers when signals are changed.

REACTION Section:

In this section you customize the response to the Trigger that you created.

1. Clicking on each **Reaction** opens a custom screen to provide necessary information.

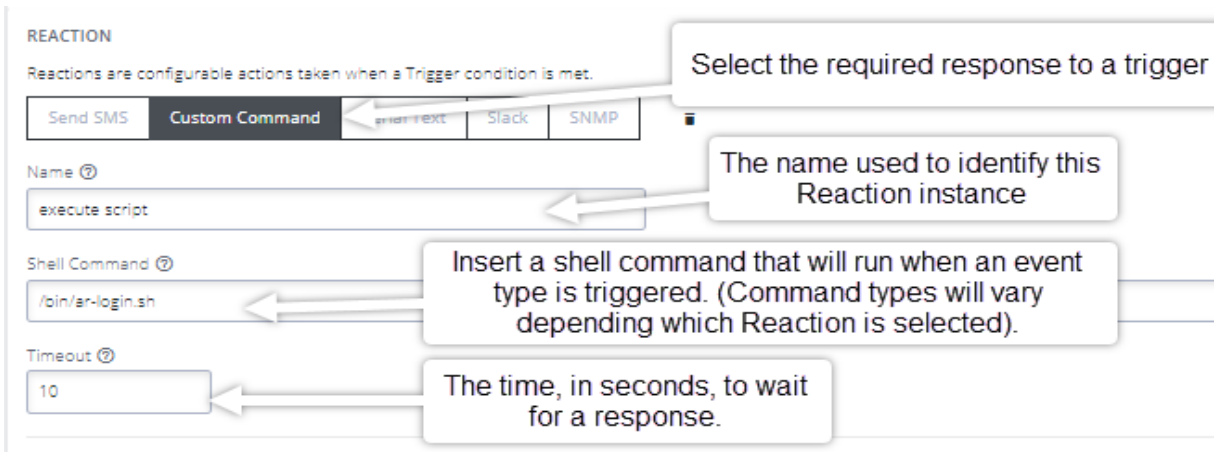

REACTION
Reactions are configurable actions taken when a Trigger condition is met.

Select the required response to a trigger

Send SMS Custom Command **Smart Text** Slack SNMP

Name The name used to identify this Reaction instance

Shell Command Insert a shell command that will run when an event type is triggered. (Command types will vary depending which Reaction is selected).

Timeout The time, in seconds, to wait for a response.

Continued...

2. To create additional Reactions, click the **Add Reaction** button.

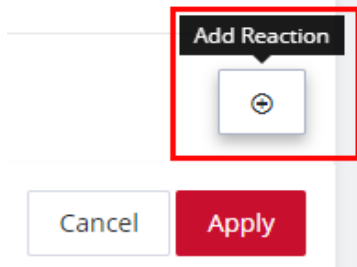

3. When you are finished, click **Apply**. A banner confirms that the Playbook settings are saved, if the Playbook is **Enabled** it is activated.
4. To monitor current **Playbooks**, click on the **Monitor > Triggered Playbooks** menu (shown below). Select the time period if desired and filter by **Name** of **Playlist** to view any that have been triggered.

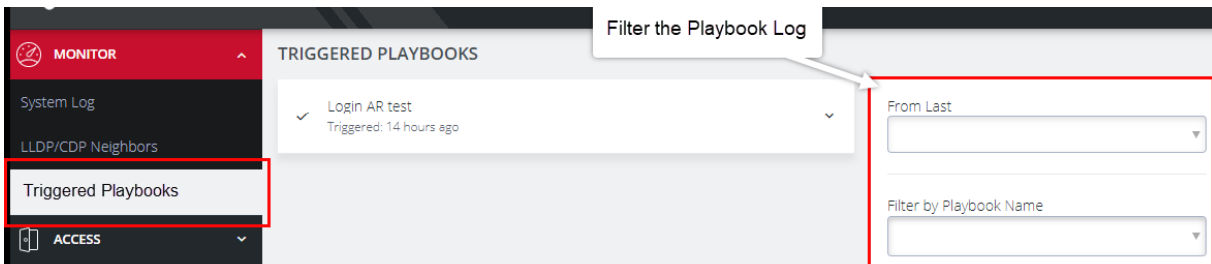

PDU's

CONFIGURE > PDUs

One or more Power Distribution Units (**PDUs**), both **Local** and **Remote** can be monitored. To add information for a **PDU**, select **Configure > PDUs**.

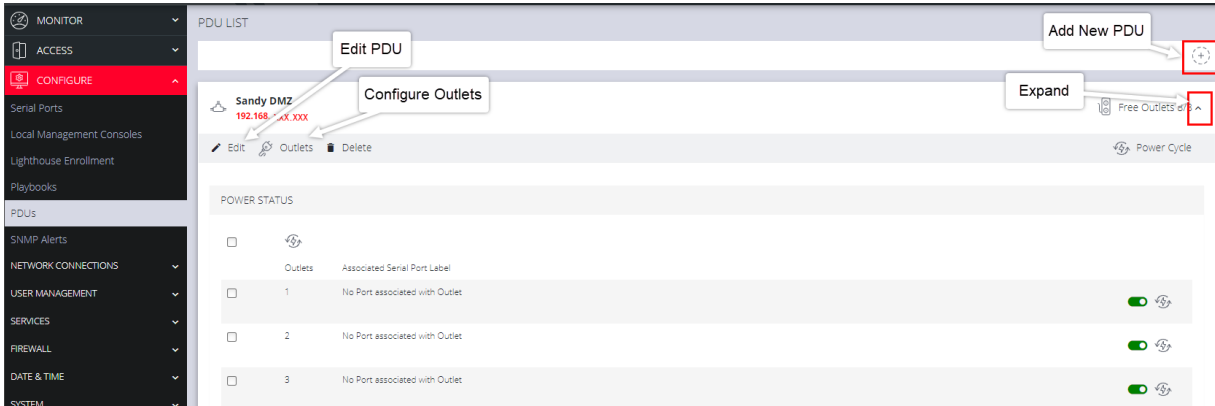

Add and Configure a PDU

PDU configuration definitions are provided in the on the "[PDU Settings Table](#)" on the next page.

1. In the PDU List page, click the **Add New PDU** button. The **Edit** page opens.
2. Enter a meaningful **Label** that will easily identify this **PDU**.
3. Select the **Monitor** checkbox.
4. Select **Local** or **Remote**.

Note: Note that **Local** or **Remote** have different settings forms.

5. Complete the **Local** or **Remote** settings in accordance with the "[PDU Settings Table](#)" on the next page.

- Click on the **Configure Outlets** link, assign a port for each of the PDUs' ports and enter a meaningful name for each outlet.

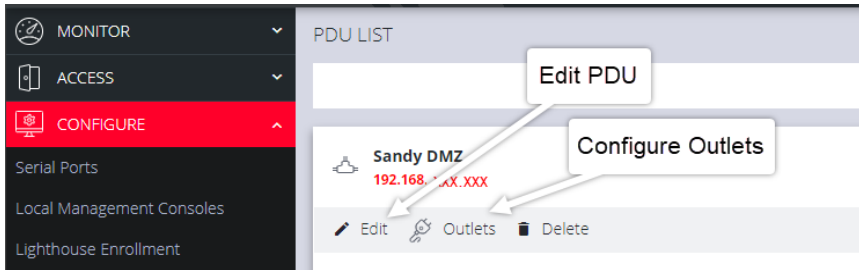

- When you are finished, click **Apply**. A green banner confirms your settings.

PDU Settings Table

PDU Settings	
Label	Enter a meaningful label that will easily identify the individual PDU .
Monitor	Click to check this box to monitor the outlet's status.
Mode	Note that (Local or Remote have different settings forms).
Driver	Select the appropriate driver compatible with this PDU.
Local Mode Only	
Port	The serial port that the PDU is connected to.
Username	Enter the Username to use when connecting.
Password	User password to use when connecting to the device.

The table is continued on the following page...

Continued...

Remote Mode Only	
Address	The remote address of the PDU.
SNMP Protocol	Click the drop-down arrow and select the correct transport protocol used to communicate with the PDU. The default value is UDP.
Version	The version of SNMP to use, V1, V2c and V3 are supported. The default value is V1.
Community	Enter a group name authorized to communicate with the device for SNMP versions 1 and 2c.

After you have created **PDUs**, you can **Edit** or **Delete** them from the **Configure > PDUs** page.

PDU Operation

After the PDU has been created and configured, PDU operation is simple. For any PDU that has Monitoring set to **Enabled**, the **Toggle** on/off switch will power-on or power-off the PDU, and the **Cycle** button cycles the PDU through a power-down and power-up cycle.

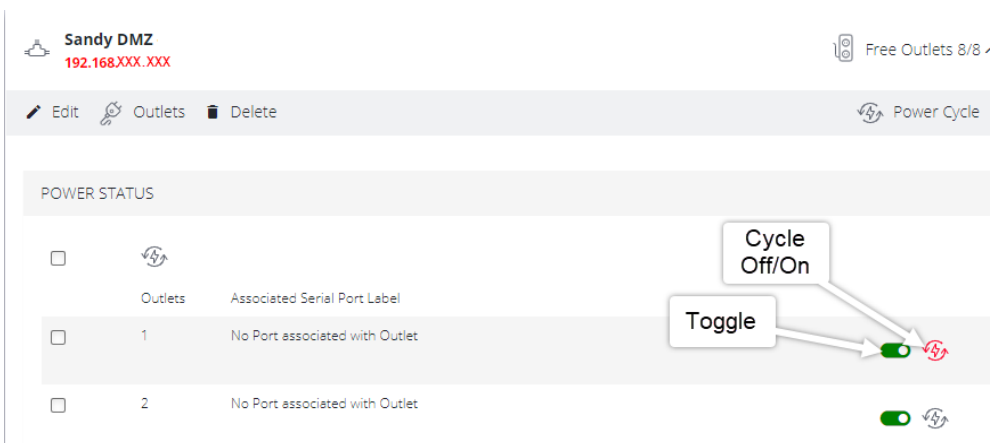

The screenshot shows the configuration page for a PDU named "Sandy DMZ" with IP address "192.168.XXX.XXX". At the top right, it indicates "Free Outlets 8/8". Below the header, there are buttons for "Edit", "Outlets", "Delete", and "Power Cycle". The main section is titled "POWER STATUS" and contains a table with columns for "Outlets" and "Associated Serial Port Label".

Outlets	Associated Serial Port Label
1	No Port associated with Outlet
2	No Port associated with Outlet

At the bottom right of the table, there are two control buttons: a "Toggle" button (a green switch) and a "Cycle Off/On" button (a circular arrow icon). Arrows from callout boxes point to these buttons.

System Alerts

[CONFIGURE > System Alerts > General/Power/Temperature/Networking](#)

Tip: For more detailed information about configuring SNMP Alerts see the individual topic pages that follow.

System Alert Managers can be added or deleted under [Configure > Services > "SNMP Alert Managers"](#) on page 177, for the following:

- **General:** Covers notification for the following causes.
 - **Authentication:** Notifies when a user attempts to log in via SSH, REST API, Web GUI, or the device's serial ports. An alert is sent regardless of whether the log in has succeeded or failed.
 - **Configuration Change:** For changes that occur to the system configuration.
- **Power:** When voltage SNMP alerts are enabled, network operators are immediately notified should the PSU begin operating outside design tolerances.
- **Temperature:** When system temperature alerts are enabled, network operators are immediately notified should the system begin operating outside user-defined tolerances.
- **Networking (Cell Signal Strength):** Be notified when cell signal strength leaves or re-enters the selected range, or when the network link state changes. A slider adjusts the upper and lower signal strength.

Tip: Manage the system settings on the [CONFIGURE > System Alerts > System Alerts](#) pages.

System Alerts - General

Authentication

[CONFIGURE > System Alerts > General > Authentication](#)

Notifies when a user attempts to log in via SSH, REST API, or the device's serial ports. An alert is sent regardless of whether the log in has succeeded or failed.

1. Navigate to **Configure > System Alerts > General > Authentication**.
2. Click on the **Enabled** button to activate the function.
3. Click **Apply**. The **Details Saved** banner confirms your settings.

Configuration

[CONFIGURE > SNMP Alerts > System > Configuration Change](#)

Notifies of changes that occur to the system configuration.

1. Navigate to **Configure > SNMP Alerts > System > Configuration**.
2. Click on the **Alerting** button to activate the function.
3. Click **Apply**. The **Details Saved** banner confirms your settings.

System Alerts - Power

[Configure > System Alerts > Power > Voltage](#)

The PSU is one of the most critical part of the Operations Manager so it is essential to ensure that the PSU is operating within its design tolerances.

When voltage SNMP alerts are enabled, network operators are immediately notified of PSU failures (subject to network connectivity and latency). Should the PSU begin operating outside design tolerances, PSU-related SNMP Alerts will trigger an alert for the following conditions:

- Output DC voltage of both PSUs

If the voltage drops too low, it risks the Operations Manager going into brown-out state. If it gets too high, it can damage components.

System generated SNMP Alerts send SNMP traps to a remote SNMP manager which alerts the user of system events. The Operations Manager can send network, power and system events to the remote SNMP manager.

Tip: The Operations Manager can send network, power and system events to the remote SNMP manager.

Enable Power Supply Syslog Alerts

[Configure > System Alerts > Power > Voltage](#)

The System Voltage Range alert sends an alert when the system reboots or the voltage on either power supply leaves or re-enters the fixed voltage range between 11.4V to 12.6V (SNMP) (or 11V to 13V Syslog).

1. Navigate to **Configure > System Alerts > Power > Voltage**.
2. Click on the **Enabled** button to activate the function.

Note: The **Disabled** button de-activates the power syslog function and power alerts will be stopped until activated again

Syslog Alert Severity

[Configure > Syslog > Add Syslog Server](#)

3. For **Power Lost** alert, click the drop-down list and select the severity level required (default level is **3 - ERROR**) when power level is outside the pre-set range.
4. For **Power Restored** alert, click the drop-down list and select the severity level required (default is **6 - INFO**) after an error condition has been fixed.
5. Click **Apply**. The **Details Saved** banner confirms your settings.

When an event occurs that causes the voltage range on any power supply to leave or re-enter the configured voltage range, it will cause an SNMP alert to be triggered. The alert will report the event type and identity and status of the PSU, as in the example below.

```
Nov 03 06:09:35 om2232 system-alerts[850]: Redundant Supply Active (PSU0 online, PSU1 online)
```

```
Nov 03 07:05:02 om2232 system-alerts[850]: Redundant Supply Inactive (PSU0 offline, PSU1 online)
```

```
Nov 03 07:05:05 om2232 system-alerts[850]: Redundant Supply Active (PSU0 online, PSU1 online)
```

To view log severity messages locally, use the journal tool command

`journalctl -f -u alert-logger -o verbose` where: f = follow. Check the alert-logger using the `systemctl status alert-logger` command.

System Alerts - Temperature

[CONFIGURE > System Alerts > Temperature](#)

It is essential to ensure that the system is operating within its design temperature as premature aging of the component can occur if the appliance is excessively hot during operation. This can lead to component failure and ultimately result in RMA.

When temperature SNMP alerts are enabled (Alerting), network operators are immediately notified (subject to network connectivity and latency) should the PSU begin operating outside user-defined temperature tolerances.

System generated SNMP Alerts send SNMP traps to a remote SNMP manager which alerts the user of temperature events.

Tip: The Operations Manager can send network, power and system events to the remote SNMP manager.

Configure SNMP System Temperature Alerts

[Configure > SNMP Alerts > System > System Temperature](#)

The System Temperature Range alert reports the system temperature (measured at **System Temperature 1** and **System Temperature 2** sensors) and sends an alert when the system temperature leaves or enters the user-configured temperature range.

1. Navigate to **Configure > System Alerts > Temperature > System Temperature**.
2. Click the Up/Down arrow to set the temperature range limiters to the required upper and lower limits.

In this image, if any temperature sensor reports the system temperature (measured at **System Temperature 1** and **System Temperature 2** sensors) to be less than 36 degrees C or greater than 67 degrees C, an SNMP alert will be triggered.

Temperature Range

36 - 67 °C
~ 97 - 153 °F

SNMP Alerts

Enabled Disabled

Tip: The temperature display is automatically converted to Fahrenheit.

3. Click on the SNMP Alerts **Enabled** button to activate the function.

Note: The **Disabled** button de-activates the function and temperature alerts will be stopped until activated again.

4. Click **Apply**. The **Details Saved** banner confirms your settings.

System Alerts - Networking (Connection Status)

[Configure](#) > [SNMP Alerts](#) > [Networking](#) > [Network Connection Status](#)

The alert related to this functionality is the Network Connection Status which sends an alert when cell signal strength leaves or re-enters a user-defined range, or, when the network link state changes. A slider adjusts the upper and lower signal strength limits.

Configure Signal Strength Alerts

[Configure](#) > [SNMP Alerts](#) > [Networking](#) > [Network Connection Status](#)

To set the Network Connection Status signal strength boundaries:

1. Navigate to [Configure](#) > [SNMP Alerts](#) > [Network Connection Status](#) > [Signal Strength](#) page.
2. Click on the **Alerting** button to activate the function, this also activates the user-defined range sliders.
3. Click+Drag the signal strength range limiters to the required upper and lower limits.

Note: The **Not Alerting** button de-activates the function and signal strength alerts will be stopped until activated again.

4. Click **Apply**. The **Details Saved** banner confirms your settings.

NETWORK CONNECTION STATUS

Be notified when cell signal strength leaves or re-enters the range, or when the network link state changes.

Alerting Not Alerting

Signal Strength

33 66

0 25 50 75 100

Apply

When an event occurs that causes the signal strength to re-enter the user-defined range, an SNMP alert will be triggered.

In the above image, if any anomaly occurs that causes the signal strength to drop below 33 or above 66, an SNMP alert will be triggered.

Network Connections

[CONFIGURE > NETWORK CONNECTIONS](#)

The **Network Connections** menu contains the **Network Interfaces**, **IPsec Tunnels** and **Static Routes** settings.

22.11.0	CONFIGURE Menu	78
---------	----------------	----

Network Interfaces

[CONFIGURE > NETWORK CONNECTIONS > Network Interfaces](#)

The interface supports both IPv4 and IPv6 networks. The IP address of the unit can be setup for Static or DHCP. The following settings can be configured for network ports:

- IPv4, IPv6
- Static and/or DHCP
- Enabling or disabling network interfaces
- Ethernet Media types

For detailed information about Network Interface configuration and adding a new connection, see ["Change Network Settings" on page 35](#).

For information about VLAN interfaces, bridges and bonds, see ["Network Aggregates - Bonds and Bridges" on page 95](#)

DNS Configuration

DNS settings such as Name Servers and Search Domains can be configured for each network interface, which will override the DHCP provided settings.

Name servers allow the system to resolve hostnames to IP addresses to communicate with remote systems. Search domains allow the system to resolve partially qualified domain names (PQDN) by appending entries from the listed search domains to form a fully qualified domain name (FQDN).

When adding an interface to a Bond or Bridge, it will use the DNS configuration of the aggregate interface.

Note: Interfaces must have at least one network connection to be able to perform DNS resolution.

Configure DNS via the Web UI

[CONFIGURE > NETWORK CONNECTIONS > Network Interfaces](#)

On the Network Interfaces page, select the desired interface and click the Edit link.

Name Servers

1. Add one or more name servers to the list by clicking the **Add Name Server** button.
2. Name servers can be IPv4 or IPv6 addresses.
3. Name servers can be removed from the list by clicking the

Name Server 

10.23.66.123 

10.23.66.124 

fd07:2218:1350:49::1:1531 

 Add Name Server

Delete button next to each row.

4. Click **Apply** to save the changes.

DNS Search Domains

1. Add one or more DNS search domains to the list by clicking the **Add Search Domain** button.
2. Search domains should be fully qualified domain names.
3. Search domains can be removed from the list by clicking the **Delete** button next to each row.
4. Click **Apply** to save the changes.

Search Domain 

office.example.com 

sales.example.com 

development.example.com 

 Add Search Domain

Configure DNS via the Command Line

Description	Command
Display configured DNS settings for an interface	<pre>ogcli get physif "net1"</pre>
Update DNS settings for an interface	<pre>ogcli update physif "net1" << END dns.nameservers[0]="1.1.1.1" dns.nameservers[1]="1.0.0.1" dns.search_domains[0]="example.net" dns.search_domains[1]="example.com" END</pre>

Description	Command
Check unbound service status	<pre>systemctl status unbound.service</pre>
List forward-zones in use	<pre>unbound-control list_forwards</pre>

Dual SIM

[CONFIGURE > NETWORK CONNECTIONS > Network Interfaces > Cellular Interface \(LTE\)](#)

Operations Manager has been available for some time with support for two SIM cards/slots, whereby, it is possible designate which SIM slot is the Active SIM that is normally used by the OM for OOB communications (in Automatic failover mode this SIM is termed the Primary SIM). The secondary SIM is used as a failover SIM. This feature increases the reliability of the OOB solution by providing redundant Out-Of-Band access over a cellular connection.

Note: The terminology changes when SIM Failover policy is switched from **Manual** to **Automatic**. In Manual failover mode the active SIM is designated ACTIVE, whereas in Automatic failover mode the active SIM is designated PRIMARY.

With the Dual SIM feature activated, in the event of a failure of OOB communications through the Active SIM, it is possible to manually de-select the failed SIM and activate the secondary SIM by making *it* the Active SIM. This changeover allows OOB communications to resume through the newly designated Active SIM.

Display SIM Status and Signal Strength

Note: For information about configuring the **Signal Strength Thresholds** see: ["System Alerts" on page 70](#)

1. Navigate to [Configure > Network Connections > Network Interfaces](#).
2. Click on the **Cellular Interface (LTE)** row.

Cellular Interface (LTE)

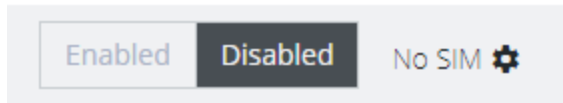

3.

The information bar expands, and the page shows the current status of the active and inactive SIM cards.

Note: If the unit does not have a cell modem (-L) then the cellular interface will not be visible.

4. The active SIM indicates the color of the signal strength based upon the selected thresholds in **Configure** → **SNMP Alerts** under the **Networking Signal Strength Alert**.

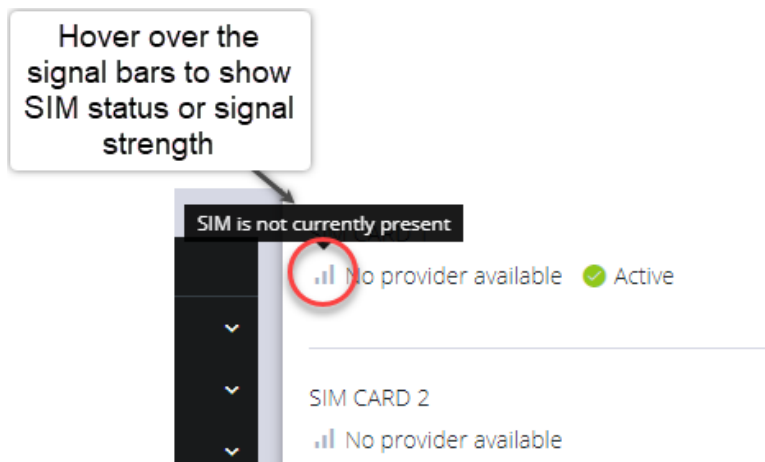

The signal bar color (not the number of bars) indicates signal strength:

- **Green** if signal is above the higher threshold.
- **Amber** if signal is between lower and higher threshold.
- **Red** if signal is below the lower threshold,
- **Grey** for 0 or not active,

5. Click the **Refresh** button to display the current signal strength of the active SIM.



Note: When the **Refresh** button is clicked the signal strength is only updated for the active SIM. If you would like to know what the other SIM Signal Strength is, you need to activate it, let the modem come back online, which may take 3 minutes or more.

Installing A New SIM Card

Before installing a new SIM card, the OM must first be powered down. This can be done by switching off the power supply and waiting until the OM has shut-down. Install the new SIM card into its slot, then restart the OM.

Note: The OM will not recognize the new SIM card unless a shut-down and restart is performed. The new SIM card will be read during start-up.

Select The Active SIM (Manual Failover Mode)

Switching the active SIM must be done manually. To switch the Active SIM:

1. Navigate to **CONFIGURE > NETWORK CONNECTIONS > Network Interfaces > Cellular Interface (LTE)**.
2. Click the **Settings cog** , this will display the **MANAGE CELLULAR INTERFACE (LTE)** page and the current status of both SIM slots, including the current carrier name.



3. On the right, select the **Make Active** button of the new, active SIM and apply the change by selecting **Confirm**.
4. A pop-up alert states that this operation will take a few minutes to complete. Click **Yes** to confirm the change.

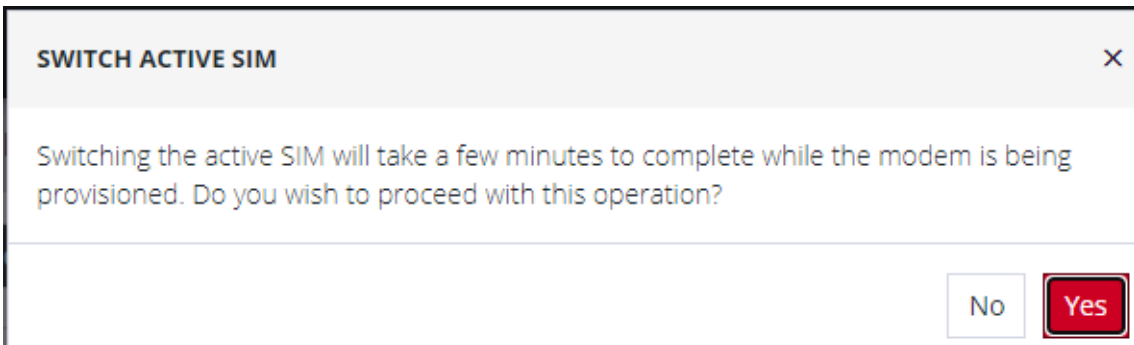

Note: During the change-over the current IP address is hidden and then returned when the modem re-connects.

5. If you require, you can monitor the interface during the changeover via the CLI with the command:.

```
watch ip address show dev wwan0
```

22.11.0	CONFIGURE Menu	86
---------	----------------	----

You can also set the SIM settings by expanding the menu for each SIM to set the APN.

If no SIM is inserted you can still select a SIM slot. If you insert a SIM it will not force it to become the active SIM.

Select The Primary SIM (Automatic Failover Mode)

Switching the primary SIM must be done manually. To switch the Primary SIM:

1. Navigate to **CONFIGURE > NETWORK CONNECTIONS > Network Interfaces > Cellular Interface (LTE)**.
2. Click the **Edit** icon, this will display the **MANAGE CELLULAR INTERFACE (LTE)** page and the current status of both SIM slots.

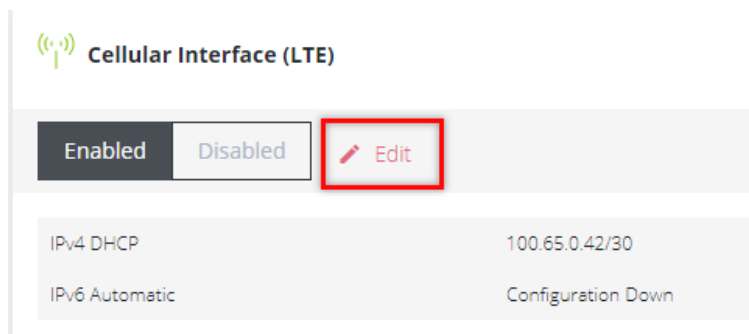

3. Ensure the cellular interface is enabled by clicking the **Enabled** button.

4. Under **Cellular SIM Failover** click the **Automatic** button, this will display the **Primary** selection buttons.

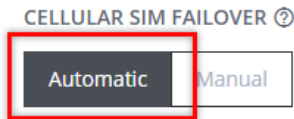

▲ Cellular SIM Failover may take a few minutes due to the need to switch firmware.

Primary - SIM CARD 1
Verizon Wireless
ICCID: 8914800005844013102
SIM Settings ▾

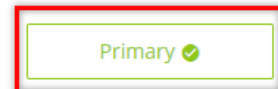

Secondary - SIM CARD 2
AT&T Wireless Inc.
ICCID: 89010303300021797361
SIM Settings ▾

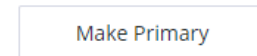

5. Click the **Primary** button of the SIM selected to be the primary SIM.
6. Click the **Confirm** button at the bottom of the page. A green banner will appear to confirm that the new settings have been saved.

Dual SIM Automatic Failover

[CONFIGURE > NETWORK CONNECTIONS > Network Interfaces > Cellular Interface \(LTE\)](#)

Operations Manager that carry two SIM cards can be configured so that either SIM card slot may be activated. In Automatic failover mode, either of the two SIM cards may be designated as the Primary SIM. (see ["Dual SIM" on page 83](#)).

Dual SIM Automatic Failover works seamlessly with the existing failover solution to provide another layer of redundancy. This feature allows the software to detect a failure in OOB communications via the Primary SIM and will automatically failover to the Secondary SIM without the need for manual operator intervention.

Options within the configuration also allow you to configure the failback settings from Secondary SIM, back to the previous Primary SIM when OOB communications have been restored. See ["Cellular Interface Policy Settings" on page 93](#).

Note: The terminology changes when SIM Failover policy is switched from **Manual** to **Automatic**. In Manual mode the active SIM is designated ACTIVE, whereas in Automatic failover mode the active SIM is designated PRIMARY.

See the image on the following page for a depiction of Primary and Secondary SIM card slots.

Either of the SIM card slots can be designated as the Primary SIM. In the following image, SIM card 1 has been designated as the Primary SIM and is currently the active SIM, while SIM card 2 is designated as the Secondary SIM which, (in the scenario below), is only activated in the event of an automatic failover such as occurs during an OOB communications failure on the Primary SIM.

CELLULAR SIM FAILOVER ⓘ

Automatic Manual

⚠ Cellular SIM Failover may take a few minutes due to the need to switch firmware.

Primary - SIM CARD 1
Verizon Wireless
ICCID: 8914800005844013102
SIM Settings ▾

Primary ✓

Secondary - SIM CARD 2
AT&T Wireless Inc.
ICCID: 89010303300021797361
SIM Settings ▾

Make Primary

Failover Modes

Features of Automatic Failover include:

- Select either **Manual** or **Automatic** SIM failover.
- Specify SIM failback policy (applicable when the Ethernet connection and primary SIM are both down):
 - **Upon disconnect** - See the table "[Cellular Interface Policy Settings](#)" on [page 93](#) for an explanation of the policy.
 - **After a Delay** (specified in minutes) - The node switches back to primary after a pre-defined time has elapsed.
 - **Never** - The node never switches back to the Primary.
- SIM failover settings allow you to configure the parameters that affect cellular data usage, for example, quicker failover (consumes more data) vs less frequent tests (consumes less data). The configuration preferences include
 - Ping test for failover from Primary to Secondary and failback from Secondary to Primary.
 - Failover settings are per SIM slot and consist of a failover and failback ping test.
- Automatic Failover functions in both dormant and non-dormant mode.

Activate or Configure Automatic Failover

[CONFIGURE](#) > [NETWORK CONNECTIONS](#)> [Network Interfaces](#) > [Cellular Interface \(LTE\)](#) > [Manage Cellular Interface \(LTE\)](#)

1. Navigate to the Cellular Interface page at: [CONFIGURE](#) > [NETWORK CONNECTIONS](#)> [Network Interfaces](#) > [Cellular Interface \(LTE\)](#).
2. Click the **Edit** link next to the Cellular Interface Enabled/Disabled switch.

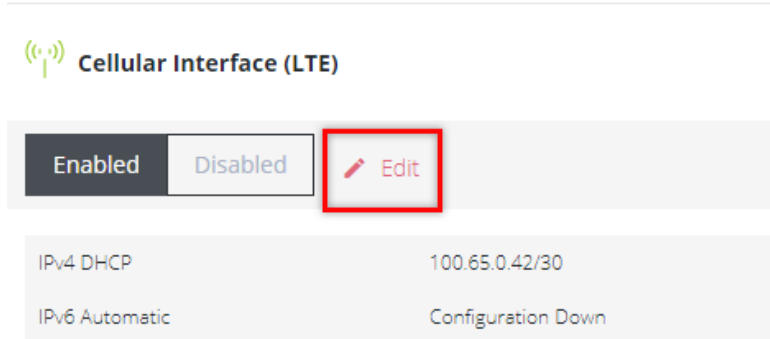

3. In the Manage Cellular Interface page, select the **Automatic** failover option.
4. Ensure the correct SIM card is selected as the Primary SIM (see 'Set Primary SIM' in "[Dual SIM](#)" on page 83).
5. Complete the Cellular Interface options in accordance with the table below.
6. Click **Confirm** to activate the failover policy settings, a green banner will confirm the settings are enabled.

Cellular Interface Policy Settings

MANAGE CELLULAR INTERFACE (LTE) Properties	
Field	Definition
CELLULAR SIM FAILOVER - Manual/Automatic.	Automatically switch between the Primary SIM Card and the secondary SIM Card on dis-connection.
Primary SIM Failover	
Failover Probe Address.	Network address to probe in order to determine if connection is active. Note: The probe address accepts IPv4, IPv6 addresses and hostnames.
Test interval (seconds).	The number of seconds between connectivity probe tests.
Pings per test.	The maximum number of times a single ping packet is sent per probe before considering the probe failed.
Consecutive test failures before failover.	The number of times a probe must fail before the connection is considered failed.
Failback Policy	
Never / Delayed / On Dis-connect.	Select the policy to be used to determine Failback recovery from the Secondary SIM Card back to the Primary SIM Card.
Never	No Failback recovery is attempted.
Delayed	Attempted failback after n minutes. The number of minutes after failover to the secondary SIM Card that the connection should failback to the Primary SIM Card.

On Disconnect	Secondary SIM Failback
	<p>Failback Probe Address ie. The Network address to probe in order to determine if the connection is active.</p>
	<p>Test Interval The number of seconds between connectivity probe tests (this not the same thing as Attempted Failback).</p>
	<p>Pings per Test The maximum number of times a single ping packet is sent per probe before considering the probe failed.</p>
	<p>Consecutive Test Failures (before failover) The number of times a probe must fail before the connection is considered failed.</p>

Network Aggregates - Bonds and Bridges

[CONFIGURE > NETWORK CONNECTIONS > Network Interfaces > Select the target interface](#)

Bridges

Network bridges allow connecting of multiple network segments together so that they may communicate as a single network.

Operations Manager models with an integrated switch (OM1204-4E, OM1208-8E and OM2224-24E) have a bridge configured by default that includes all of the switch ports, which can be edited or deleted as required.

Definitions of the bridge details as in the **Bridge Form Definitions** table later in this topic.

Note: Whether creating a new bridge or editing an existing bridge the page is very similar.

Create A New Bridge

To create a new bridge:

1. Navigate to the **Configure > Network Connections > Network Interfaces** page on the Web GUI.
2. Click on the **New Bridge**  button that is located at the top-right of the window.
3. Select which interface will serve as the primary interface for the new bridge.

Note: When the primary interface is selected, its MAC address is displayed in the MAC address field. This MAC address is inherited by the new bridge interface.

4. Complete the new bridge details form as in the **Bridge Form Definitions** table.
5. Click the **Create** button to finalize the creation of the new bridge.

Edit an Existing Bridge

To edit an existing bridge:

1. Navigate to the **Configure > Network Connections > Network Interfaces** page on the Web GUI.
2. Click on the bridge that you would like to edit, the bridge details are expanded.
3. Click on the bridge **Edit** button that is located next to the Enable / Disable toggle buttons.
4. Select which interface will serve as the primary interface for the new bridge.
5. Change the bridge details as required in accordance with the **Bridge Form Definitions** table.
6. Click the **Update** button to finalize the edit process. Updating the bridge will temporarily interrupt network activity on this interface.

Note: Editing the primary interface will not update its connections.

Edit Bridge - Form Definitions

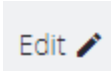
New Bridge Field	Definition
Description	The editable Description field allows you to add a description of the interface. If the description field is not completed the field will default to a computed value to describe the interface.
Enable Spanning Tree Protocol	<p>Enable or disable Spanning Tree Protocol.</p> <p>See "Spanning Tree Protocol" on page 102.</p>
Network Interface Selection	<p>Click the checkbox of each network interface you want to include in the bridge.</p> <p>Available interfaces include Ethernet and VLAN interfaces that are not part of another bond or bridge.</p> <p>Bond interfaces can be included in a bridge by using the ogcli tool. See Support for Bonds in Bridges on Zendesk.</p>
Primary Interface	Select the interface that is to be used for selecting the MAC address of the aggregate. The new bond inherits the MAC address of the primary interface. On creation, any Network Connections which exist on the Primary Interface will be attached to the Bond/Bridge after it is initially created. When a Bond/Bridge is deleted, any Network Connections which exist on the aggregate interface are handed over to the Primary Interface.
Inherited Connections	When the Primary Interface is selected, the connections inherited by the new bridge are listed here.
	Click to edit the details of an existing interface.

Bonds

Network bonds allow combining two or more network interfaces together into a single logical "bonded" interface for load balancing, redundancy or improved performance depending on the bond mode used.

Definitions of the bond details as in the **Bond Form Definitions** table later in this topic.

Note: Whether creating a new bond or editing an existing bond the page is very similar.

Create A New Bond

To create a new bond:

1. Navigate to the **Configure > Network Connections > Network Interfaces** page on the Web GUI.
2. Click on the **New Bond** button that is located at the top-right of the window.
3. Select which interface will serve as the primary interface for the new bond.

Note: When the primary interface is selected, its MAC address is displayed in the MAC address field. This MAC address is inherited by the new bond interface.

4. Complete the new bond details form as in the **Bond Form Definitions** table.
5. Click the **Create** button to finalize the creation of the new bond. Network connections from non-primary interfaces will be deleted when the new bond is created.

Edit an Existing Bond

To edit an existing bond:

1. Navigate to the **Configure > Network Connections > Network Interfaces** page on the Web GUI.
2. Click on the bond that you would like to edit, the bond details are expanded.
3. Click on the bond **Edit** button that is located next to the Enable / Disable toggle buttons.
4. Change the bond details as required in accordance with the **Edit Bond Form Definitions** table below.
5. Click the **Update** button to finalize the edit process. Updating the bond will temporarily interrupt network activity on this interface.

Note: Editing the primary interface will not update its connections.

Edit Bond - Form Definitions

New Bond Field	Definition
Description	The editable Description field allows you to add a description of the interface. If the description field is not completed the field will default to a computed value to describe the interface.
Mode	The mode determines the way in which traffic sent out via the bonded interface is dispersed over the real interfaces. Available modes are:
	Round Robin Balancing - Packets are sequentially transmitted/received through each interface, one by one.
	Active Backup - If the active secondary interface is changed during a failover, the bond interface's MAC address is then changed to match the new active secondary's MAC address.
	XOR Balancing - Balances traffic by splitting up outgoing packets between the Ethernet interfaces, using the same one for each specific destination when possible.
	Broadcast - All network transmissions are sent on all secondary interfaces. This mode provides fault tolerance.
	802.3ad (Dynamic Link Aggregation) - Aggregated NICs act as one NIC, but also provides failover in the case that a NIC fails. Dynamic Link Aggregation requires a switch that supports IEEE 802.3ad.
	Transmit Load Balancing - Outgoing traffic is distributed depending on the current load on each secondary interface. Incoming traffic is received by the current secondary interface. If the receiving secondary fails, another secondary takes over the MAC address of the failed secondary.

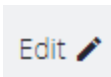
	<p>Adaptive Load Balancing - Includes transmit load balancing (tlb) and receive load balancing (rlb) for IPv4 traffic and does not require any special switch support.</p>
Poll Interval	<p>The poll interval specifies the MII link monitoring frequency in milliseconds. This determines how often the link state of each secondary is inspected for link failures. A value of zero will disable MII link monitoring.</p>
Network Interface Selection	<p>Click the checkbox of each network interface you want to include in the bridge.</p> <p>Available interfaces include Ethernet and VLAN interfaces that are not part of another bond or bridge.</p>
Primary Interface	<p>Select the interface that is to be used for selecting the MAC address of the aggregate. The new bond inherits the MAC address of the primary interface. On creation, any Network Connections which exist on the Primary Interface will be attached to the Bond/Bridge after it is initially created. When a Bond/Bridge is deleted, any Network Connections which exist on the aggregate interface are handed over to the Primary Interface.</p>
Active Connections	<p>When the Primary Interface is created, the connections inherited by the new bond are listed here. When edited, Active Connections on the aggregate will not be updated if the primary interface is changed.</p>
	<p>Click to edit the details of an existing interface. Updating a bridge will temporarily interrupt network activity on the interface when you click the Update button.</p>

Spanning Tree Protocol

[CONFIGURE > NETWORK CONNECTIONS > Network Interfaces > Select the target interface](#)

Spanning Tree Protocol (STP) allows an Operations Manager to discover and eliminate loops in network bridge links, preventing broadcast radiation and allowing redundancy.

When STP is implemented on switches to monitor the network topology, every link between switches, and in particular redundant links, are cataloged. The spanning-tree algorithm blocks forwarding on redundant links by setting up one preferred link between switches in the LAN. This preferred link is used for all Ethernet frames unless it fails, in which case a non-preferred redundant link is enabled.

Note: STP Limitations

If multiple bridges are created on the same switch, they should not be used on the same network segment as they have the same MAC addresses; therefore, STP will likely not work correctly as they will have the same bridge id.

Rapid Spanning Tree Protocol (RSTP), Multiple Spanning Tree Protocol (MSTP) and other proprietary protocols are not supported.

The bridge settings relating to STP cannot be changed from the default values shown below:

group_address

forward_delay (default is 15)

hello_time (default is 2)

max_age (default is 20)

priority (default is 32768 (0x8000))

Enable STP in a Bridge

To enable STP you can use the UI or CLI. The procedures are:

Bridge With STP Enabled - UI

CONFIGURE > NETWORK CONNECTIONS > Network Interfaces > Select the target interface > New Bridge page

1. In the **Network Interfaces** page, click the **Create New Bridge** button.
2. Click to select the **Enable Spanning Tree Protocol** option.

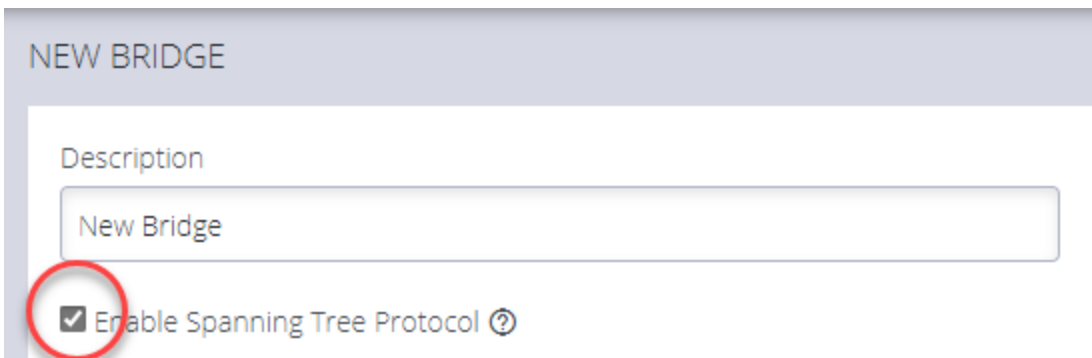

NEW BRIDGE

Description

New Bridge

Enable Spanning Tree Protocol ?

Bridge With STP Enabled - OGCLI

```
admin@om2248:~# ogcli get physif system_net_physifs-5
  bridge_setting.id="system_net_physifs-5"
  bridge_setting.stp_enabled=true
  description="Bridge"
  device="br0"
  enabled=true
  id="system_net_physifs-5"
  media="bridge"
  name="init_br0"
  slaves[0]="net2.3"
```

Bridge With STP Disabled - OGCLI

```
admin@om2248:~# ogcli update physif system_net_physifs-5 bridge_
setting.stp_enabled=false

  bridge_setting.id="system_net_physifs-5"
  bridge_setting.stp_enabled=false
  description="Bridge"
  device="br0"
  enabled=true
  id="system_net_physifs-5"
  media="bridge"
  name="init_br0"
  slaves[0]="net2.3"
```

IPsec Tunnels

[CONFIGURE > NETWORK CONNECTIONS > IPsec Tunnels](#)

The Opengear Operations Manager (OM) can use IPsec to securely connect and route between two or more LANs (sometimes referred to as site to site, LAN-to-LAN, L2L VPN), or as a single client endpoint connecting to a central LAN or endpoint (sometimes referred to as host to site, or host to host).

IPsec does not make a formal distinction between initiator and responder, however the Opengear OM can both initiate tunnels (as the "initiator") and have other devices initiate tunnels to it (as a "responder").

Create, Add or Edit IPsec Tunnels

On the IPsec Tunnels page, you can create, edit, and delete IPsec tunnels.

To create an IPsec tunnel:

1. Click **CONFIGURE > NETWORK CONNECTIONS > IPsec Tunnels**.

The IPsec Tunnels page with two tunnels previously created.

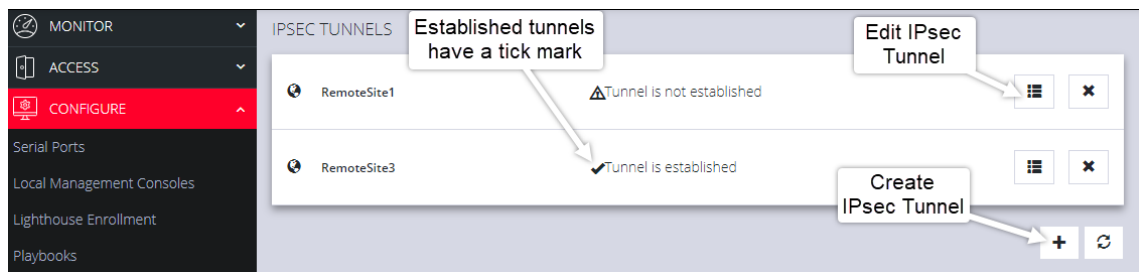

*If there are no existing tunnels, this **Create Tunnel** button is displayed:*



2. Click **CREATE TUNNEL**. This opens the **EDIT IPSEC TUNNEL** page.

NAME and STATUS

3. In the **Name** section of the page, give your new tunnel a unique name and click the **Enabled** button.

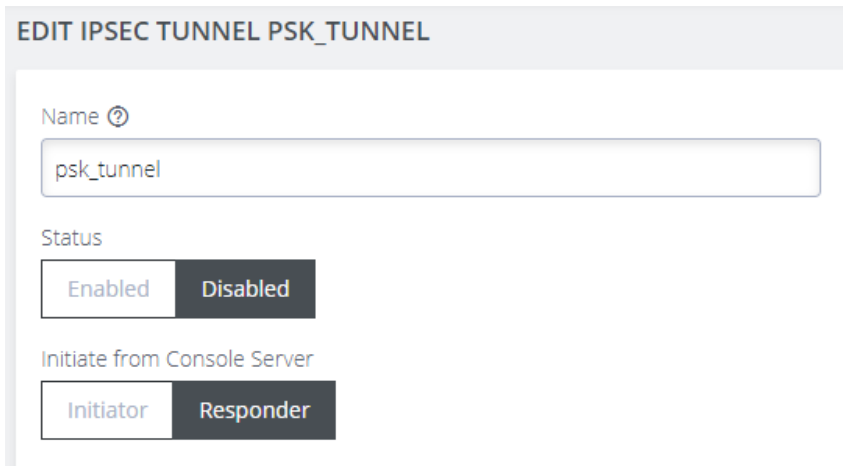

EDIT IPSEC TUNNEL PSK_TUNNEL

Name ⓘ

psk_tunnel

Status

Enabled Disabled

Initiate from Console Server

Initiator Responder

4. Set the Console Server to be the **Initiator** or **Responder**.

Note: When **Initiator** is selected, the node will actively initiate the tunnel by sending IKE negotiation packets to the remote end.

IKE SETTINGS

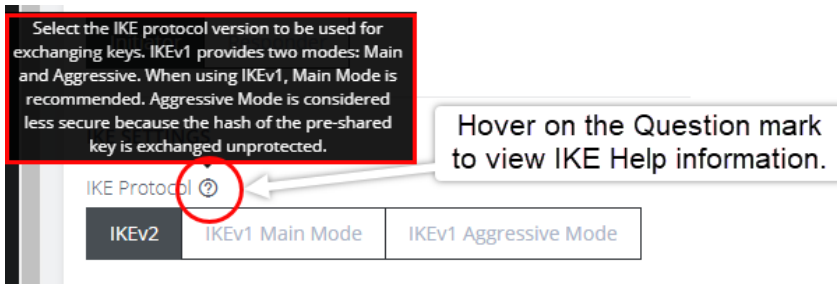

Select the IKE protocol version to be used for exchanging keys. IKEv1 provides two modes: Main and Aggressive. When using IKEv1, Main Mode is recommended. Aggressive Mode is considered less secure because the hash of the pre-shared key is exchanged unprotected.

Hover on the Question mark to view IKE Help information.

IKE Protocol ⓘ

IKEv2 IKEv1 Main Mode IKEv1 Aggressive Mode

Continued...

5. Select an **IKE Protocol** version to use for exchanging keys. IKEv1 provides two modes: **Main** and **Aggressive**. When using IKEv1, Main Mode is recommended. Aggressive Mode is considered less secure because the hash of the pre-shared key is exchanged unprotected.
6. Select the **Algorithm Proposal**. This is a set of algorithms used for negotiation when attempting to establish the IPsec tunnel. By default, the node will attempt to negotiate the tunnel using a list of common algorithms which are considered safe. Alternatively, a set of default proposals that guarantee Perfect Forward Secrecy (PFS) can be selected.
7. Select **Initiate** to actively initiate the tunnel by sending IKE negotiation packets to the remote end.
8. Set up the **Phase 1** and **Phase 2** time interval between the key material refresh of the IKE and Child.

AUTHENTICATION

OM Authentication can use PSK or PKI.

9. **For pre-shared key (PSK) authentication**, enter a pre-shared secret key; both ends of the tunnel must use the same key.

Tip:

To construct ID_USER_FQDN identities, use `user@example.com`

To construct ID_FQDN type identities, use `@host.example.com`

If left blank, the outer local IP address of the tunnel is used as the identity.

10. Enter a **Local ID** Identity or IP address for the local end of the tunnel. If left blank, the outer-local IP address is used as the source address of the tunnel.
11. **For Public Key Infrastructure (PKI) authentication**, upload the certification bundle file or, drag and drop the file into the Certificate Bundle field.

TUNNEL SETTINGS

12. Select **Enabled** if enforced UDP encapsulation is required. When enabled, the IKE daemon can simulate the NAT detection payload.

ADDRESSING

13. Enter the **Local Address** to be used as the source address of the tunnel. If left blank, IPsec will automatically use a default.
14. Enter a **Local Subnet**. Specify local traffic to be tunneled. When no subnets are specified, only traffic originating from this device will be tunneled.
15. Enter the **Remote Address** or hostname for the remote end of the tunnel. If left blank, IPsec will accept initiation packets from any address.
16. Enter the **Remote Subnet**. Specify addresses or subnets that are behind the remote end of this tunnel. If no subnet is specified, only traffic originating from the outer remote address will be accepted.

DEAD PEER DETECTION

Tip: Dead Peer Detection may be used to support long-lived tunnels.

Dead Peer Detection (DPD) is a method used by nodes to verify the current existence and availability of IPsec peers. A node performs this verification by sending encrypted IKE Phase 1 notification payloads (R-U-THERE messages) to a peer and waiting for DPD acknowledgments (R-U-THERE-ACK messages) from the peer.

Continued...

You can enable DPD and configure the various options to fine-tune the functionality:

DEAD PEER DETECTION

Dead Peer Detection

Disabled Enabled

Delay [?] Seconds Timeout [?] Seconds Action [?]

- **Delay** - the time interval between polling the peer (default is 60 seconds).
- **Timeout** - the waiting time before deciding that a peer connection is not live (default is 90 seconds).
- **Action** - the action to be performed when a connection is timed-out. (default is Restart).
 - **Restart** will immediately attempt to renegotiate the tunnel.
 - **Clear** will close the CHILD_SA.
 - **Trap** will catch matching traffic.

ENABLE the IPsec TUNNEL

17. When you have completed the IPsec Tunnel set-up process, ensure the IPsec tunnel status is set to **Enabled**, then, click **Save**.

The new tunnel is now listed on the **CONFIGURE > NETWORK CONNECTIONS > IPsec Tunnels** page.

Static Routes

[CONFIGURE > NETWORK CONNECTIONS > Static Routes](#)

Static routes are predefined paths that traffic can be configured to take through the network for purposes such as security, cost or to override the default route.

The list of configured static routes are displayed in a table with their current status indicated by the status column.

Status	Meaning
Installed	The route is installed in the routing table.
Not Installed	The route may not be currently installed, but should update in a moment.
Error	The route failed to be installed.
Failed to fetch status	There is an error with the system and status failed to be obtained. This is a temporary error and should update in a moment.
The network interface is disabled	The static route is bound to an interface which is not enabled.
The network interface is disconnected	The static route is bound to an interface which is not connected.
The network interface has no active connections	The route cannot be installed as there are no active connections on this interface.

Configure Static Routes

On the Static Routes page you can add, edit or delete static routes.

Note: Only basic validation is performed when static routes are saved. Check the status column to ensure your route is installed and working correctly.

Create a static route

1. Click the **Add** button to navigate to the creation page.
2. Enter a valid IPv4 or IPv6 destination address or network, followed by the netmask in CIDR notation. The destination address/network must be unique.
3. Enter the gateway or select an interface for the static route to use.
4. Optionally, provide a metric for the route. Routes with a lower metric value are higher priority.

Destination Address	Default Metric
IPv4	0
IPv6	1024

5. Click the **Apply** button to save the changes.
6. If the changes are saved successfully you are returned to the Static Routes list page.
 - If there is an error with the configuration and the route fails to install, a red banner is displayed.
 - If the route installed successfully, a green success banner is displayed.

7. The current status of the configured route is displayed in the table, which may change depending on the status of the network configuration.

Edit a static route

1. Click the description of the desired static route in the list to access the **Edit** page.
2. Update the details of the static route.
3. Click apply to save the changes.

Delete a static route

1. Click the description of the desired static route in the list to access the **Edit** page.
2. Click the **Delete** button at the top-right of the page.
3. Click **Yes** to confirm the action.
4. If the route was removed from the routing table as expected, a green success banner is displayed.

Managing Static Routes via Command Line

Administrative users can also view the status and perform configuration of static routes via the command line interface.

After creating or modifying a route via the command line, you should take note of the route id and confirm that it has been installed successfully in the routing table.

Description	Command
Display IPv4 installed routes	<pre>ip route</pre>

Description	Command
Display IPv6 installed routes	<pre data-bbox="602 327 1398 422">ip -6 route</pre>
Display all route information	<pre data-bbox="602 464 1398 558">ip route show table all</pre>
Show status of configured routes via ogcli	<pre data-bbox="602 600 1398 684">ogcli get monitor/static_routes/status</pre>
Get static route configuration via ogcli	<pre data-bbox="602 789 1398 873">ogcli get static_routes</pre>
Create static route via ogcli	<pre data-bbox="602 926 1398 1346">ogcli create static_route << END destination_address="1.1.1.1" destination_netmask=32 gateway_address="1.1.1.1" interface="net1" metric=0 END</pre>
Update static route via ogcli	<pre data-bbox="602 1377 1398 1629">ogcli update static_route "1.1.1.1" << END interface="net2" metric=100 END</pre>
Delete static route via ogcli	<pre data-bbox="602 1671 1398 1755">ogcli delete static_route "1.1.1.1"</pre>



Network Resilience

[CONFIGURE > NETWORK RESILIENCE >](#)

Under the NETWORK RESILIENCE menu, you can manage Out-of-Band (OOB) and IP Passthrough settings.

22.11.0	CONFIGURE Menu	114
---------	----------------	-----

Out Of Band Failover

[CONFIGURE](#) > [NETWORK RESILIENCE](#) > [OOB Failover](#)

Out-of-Band (OOB) Failover detects network disruption via the probe interface, and automatically activates a cellular or ethernet interface connection to re-establish network access.

OOB failover requires an IPv4 address (in dotted decimal format), or an IPv6 address, or a domain name, which is always reachable and unlikely to change. When OOB failover is enabled, the node regularly pings this address, using the probe interface, to check for network connectivity.

Enable Out-of-Band Failover

1. To manage Out-of-Band Failover, navigate to the **CONFIGURE** > **NETWORK RESILIENCE** > **OOB Failover** page

FAILOVER SETTINGS

Status ?

 Enabled Disabled

Probe Interface ?

Probe Address ?

Probe Interface: this is the interface that will be used to test if ping can reach the configured address

Probe Address: the ipv4 or ipv6 or domain name of the address that will be “pinged”

2. In the **Failover Interface** section, select the failover interface from the drop-down list.

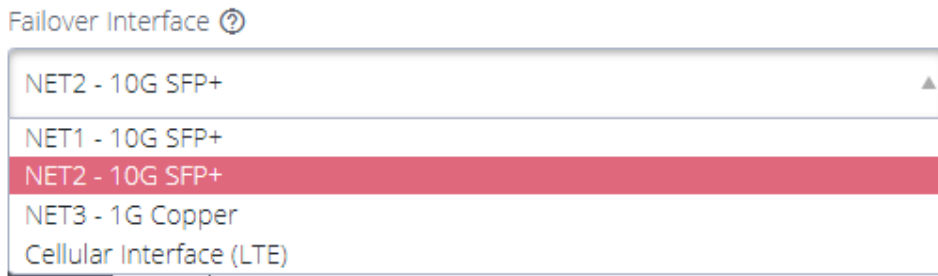

Configurable probe (failover from) and failover (failover to) interfaces are shown below:

NET1 - the default probe interface.

Cellular - the default failover interface for cellular-capable models.

NET2 - the default failover interface for non-cellular models.

3. When you have completed the OOB Failover set-up, ensure the OOB Failover status is set to **Enabled**, then, click **Apply**, a confirmation is displayed.
4. On the **Network Interfaces** page the Failover Interface will display "Configured for OOB Failover" beside the interface name.

↔ Configured for OOB Failover ▼

5. When failover is triggered, the interface will be marked with the warning: **OOB Failover Active** to an Admin user when logged in.

 Failover Connection Active

Note: It may take up to five minutes for a failover to actually occur once the probe stops connecting to the probe address.

Note: The shortcut button **Enabled/Disabled** is disabled or removed when an interface is in active failover.

DNS Queries on a Dormant Failover Interface

The Dormant DNS option allows DNS queries on the failover interface to be disabled in normal operation so that DNS queries can be paused.

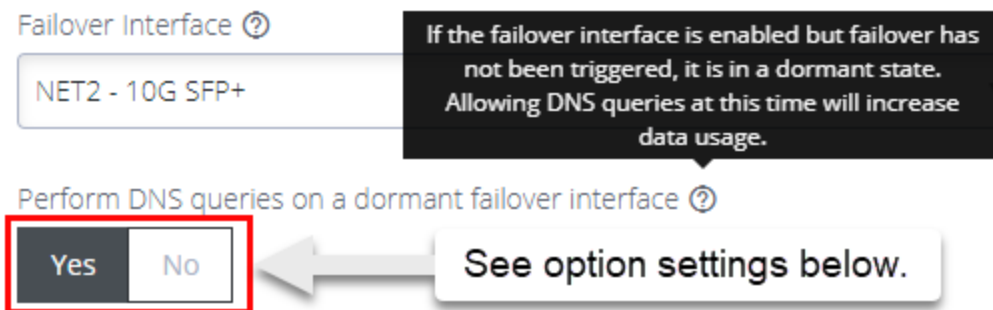

The option configures how the DNS name servers and search domains configured for the failover interface are used by the system.

- If set to **Yes**, the DNS name servers and search domains configured for the failover interface will always be available to the system for DNS name resolution. Allowing DNS queries while failover has not been triggered make it more likely that DNS requests will be made over the cellular interface which will increase data usage.
- If set to **No**, the DNS name servers and search domains will be made available to the system only when the failover state is active.

To configure the DNS name servers and search domains, see ["DNS Configuration" on page 80](#).

OOB Failover Types & Failover Behavior

OOB Setting	Failover Interface	Mode	Description
Disabled	Enabled	Always up OOB	<p>When OOB Failover is disabled, the default outgoing interface cannot be specified, the default route is selected automatically. Outbound network connections (e.g. VPN client tunnels, SNMP alerts) are established according to the main static routing table, regardless of network state.</p>
Enabled	Disabled	Failover mode	<p>Failover detection is enabled on the selected “probe” interface. The network or cellular interface remains in a down state with no network configuration.</p> <p>When failover is initiated, the network or cellular interface is started and configured. If a default route is installed on the interface, it takes precedence over the default route on the failed “probe” interface. Outbound network traffic (e.g. VPN client tunnels, SNMP alerts) are established or re-established over network or cellular connection during failover.</p> <p>The advantage of this mode is the secondary connection is completely inactive during normal operation which may be advantageous where the goal is to keep the interface off the Internet as much as possible, e.g. a cellular plan with expensive data rates and no carrier-grade NAT.</p>

Enabled	Enabled	Dormant failover	<p>Failover detection is enabled. Only inbound connections on the network or cellular interface are routed back out the network or cellular interface, to enable OOB access from remote networks (e.g. incoming SSH). Otherwise, outbound network connections (e.g. VPN client tunnels, SNMP alerts) are established according to the main static routing table, regardless of network state.</p> <p>When failover is initiated, the default route of the network or cellular interface takes precedence over the failed “probe” interface. Outbound network traffic (e.g. VPN client tunnels, SNMP alerts) are established or re-established over the network or cellular connection during failover.</p> <p>The advantage of this mode is the network or cellular connection is available for inbound out-of-band access during normal operation.</p>
---------	---------	------------------	---

IP Passthrough

Nodes with dialout support and an Ethernet port can enable a special DHCP service called IP Passthrough. When IP Passthrough is enabled, other devices (eg. the "passthrough target" or "downstream host") that are plugged into the Ethernet port will operate as if they are directly connected to the dialout network.

[CONFIGURE > NETWORK RESILIENCE > IP Passthrough](#)

1. To manage **IP Passthrough** navigate to the **CONFIGURE > NETWORK RESILIENCE > IP Passthrough** page.

SETTINGS

2. Click the IP Passthrough status checkbox to set the status to **Enabled**.
3. Click the radio button next to the interface type that is used.
4. Enter the MAC address of the downstream device that will make the DHCP requests. The MAC address of the device will be offered a DHCP lease. DHCP requests from other MAC addresses will be ignored.

IP PASSTHROUGH

SETTINGS

Enable ?

Interface ?

NET1 - 1G Copper/SFP
 NET2 - 1G Copper/SFP

Downstream MAC Address ?

SERVICE INTERCEPTS

Tip: When IP Passthrough is enabled, access to this node directly via the cellular interface will no longer work. You can configure specific ports below which will be redirected to this node instead of the downstream device.

SERVICE INTERCEPTS

When IP Passthrough is enabled above, access to this device directly via the cellular interface will no longer work. You can configure specific ports below which will be redirected to this device instead of the downstream device.

HTTPS Intercept Port 

<enter the HTTPS intercept port number>

SSH Intercept Port 

<enter the SSH intercept port number>



Apply

5. Enter the port number that is to be used for HTTPS Intercepts.
6. Enter a port to be redirected to this node's SSH service.

Tip: You can use this port to access the Operations Manager command line interface. If you leave this field blank, the SSH service intercept will be disabled.

7. When you have completed the IP Passthrough Settings and Service Intercept form, ensure the IP Passthrough status is set to **Enabled**, then, click **Apply**.



User Management

[CONFIGURE > USER MANAGEMENT](#)

Under the User Management menu, you can create, edit, and delete groups and users, as well as assign users to groups. You can also set up remote user authentication.

22.11.0	CONFIGURE Menu	122
---------	----------------	-----

Groups

[CONFIGURE > USER MANAGEMENT > Groups](#)

Groups are used to grant privileges to users. When a user is a member of a group, defined privileges may be granted to the group by an administrator. When editing a group, the (authorised) user selects from a list of devices, all of which are under the heading **SERIALLY CONNECTED DEVICES**.

Permission Changes in the Web UI

A new feature change called **Access Rights** is introduced in release 22.11 replaces the previous concept of a user *Role* and instead uses a set of configurable *Access Rights* for each group. Each access right governs access to a particular feature (or set of highly related features), with a user only having access to features for which they have an assigned access right.

Tip: To support the new permissions model several rest API endpoints have been updated for the new functionality. Wherever possible, these changes backwards compatible. See the release noted for details.

Understanding Access Rights

An access right is a permit authorizing access to a feature or collection of related features. Holders of the permit (i.e. the access right) are given access to the feature.

A user gains access rights by the following:

- Access Rights are assigned to Groups.
- Users are members of zero or more Groups.
- A User inherits all Access Rights from all the Groups they are a member of.

Some features may require the user to hold multiple access rights to access the feature through a specific interface. For example, a user needs the “right to use the web UI” and the “right to configure serial ports” to make configuration changes to a serial port through the web UI.

DEFINED ACCESS RIGHTS

There are four *defined* rights (admin, web_ui, pmshell, and port_config) as summarized in the following table.

Access Rights	Description
admin	The admin access right grants a holder access to everything; every feature and every user interface.
web_ui	<p>Permits access for an authenticated user to basic status information via the web interface and rest API. Users can:</p> <ul style="list-style-type: none"> • Make requests to the subset of endpoints that provide this same information. In both cases the user must be authenticated. • See information about their own user and groups. • See serial port status information for the specific ports the user is granted access to.
pmshell Restricted CLI	Permits access to devices connected to serial ports. Does not give permission to configure all serial ports, only to those that are added to the same group containing the pmshell rights.
Port Config	Permits access to configure serial ports. This access right gives the holder the ability to configure serial ports. This right does not give the holder the ability to access the serial port.

Tip: A right may be combined with another right for a feature to be accessible by a user. For example, `web_ui` to login and `port_config` to configure a serial port. The `port_config` right by itself is not useful.

Admin Access Right (`admin`)

Any user who was previously an Administrator role now inherits the `admin` access right, giving that user the same “can do everything” permission.

Tip: The **Admin Access** toggle switch in the Web UI hides other rights selections as Admin Access overrides all other rights.

Web UI Access Right (`web_ui`)

Any user who was previously a Console User role now inherits the `web_ui` and `pmshell` access rights and there are no functional changes for this user.

Tip: From release 22.11 in the Web UI, the **Rights** checkbox replaces the **Roles** drop-down selection.

The `web_ui` access right grants the user the ability to

- log into the Web UI,
- see a listing of serial ports (The “Access → Serial Ports” menu item) and to
- edit a restricted set of user configuration such as changing their own password.

Portmanager Shell Access Right (`pmshell`)

Any user who was previously a Console User role now inherits the `pmshell` access rights and there are no functional changes for this user.















The `pmshell` access right grants the user access to the serial port web terminals and the ability to use `pmshell` over SSH. These rights are applied only to the access ports to which they have been granted rights.

Port Configuration Access Right

The `port_config` access right grants the holder of this right the ability to make configuration changes to the serial ports they have been assigned. Note that a user without the `web_ui` right cannot login to the web UI to configure serial ports, so a user must inherit the `web_ui` from at least one group.

Access > Serial Ports View

Users with the `port_config` access right to some serial ports are able to see the **Edit** link on the **Access > Serial Ports** page for those ports only. Non-admin users with the `port_config` role are able to see any active sessions on a port, but are not able to terminate the session.

LOGGING LEVEL	ESCAPE CHARACTER			
Logging Disabled	~			
 Port-3 Port-3, 9600-8-N-1-X2	 Console Server	 0 Sessions	 	
 Port-4 Port-4, 9600-8-N-1-X2	 Console Server	 0 Sessions	 	
 Port-5 Port-5, 9600-8-N-1-X2	 Console Server	 0 Sessions		

Configure > Serial Ports View

The Configure Serial Ports page is accessible to users with the `port_config` and `web_ui` access rights appear in the navigation sidebar menu. This page lists ports that the user has both `port_config` and `web_ui` access rights.

22.11.0	CONFIGURE Menu	126
---------	----------------	-----

Tip: It is possible to edit all details on these ports, however, changing the “mode” of a port will disconnect any sessions.

Non-Admin Users

Non-admin users with `port_config` access right are able to perform Serial Port Autodiscovery on the ports that they are able to configure. If autodiscovery is already running, they will be able to see the banner but will not be able to view the autodiscovery logs or cancel the running job. Non-admin users are not able to configure the Serial Port Autodiscovery Schedule and the icon is hidden, but are able to see which ports are configured of the ports to which they have access.

Protected Groups and Users

Certain types of groups and users have protected status, meaning that they cannot be changed or deleted. Protected groups comprise the following:

`root` - The root user is hard-coded member of the admin group. As such, the root user cannot be deleted.

`admin` - The admin group cannot be disabled or changed to a non-admin group.

`netgrp` - The special ‘netgrp’ also cannot be deleted. This group is assigned to users from AAA auth that don’t have a group assigned from the authentication server.

Tip: For these protected groups no 'Delete' button appears beside them in the Web UI.

Understanding Serial Port Access

Serial ports are assigned to a group in the same way as access rights are assigned to a group, however, it is the access rights that are assigned to the same group that determine what a user can actually do with those serial ports. The access rights assigned to one group will only apply to the serial ports assigned to that same group, they do not apply to the serial ports of another group.

For example, a user in a group with `port_config` and `port-01` can configure that port but not access the device (as that requires `pmshell` access rights).

Consider the following two groups, *Accounts Admin* and *Port #03 User*:

Group Name	Accounts Admin	Port #03 User
Access Rights	<code>port_config</code> <code>web_ui</code>	<code>pmshell</code> <code>web_ui</code>
Serial Ports	<code>port-01</code> <code>port-02</code>	<code>port-03</code>

The effective rights for a user in one or both of those groups is shown in the following table. It shows how access rights assigned to one group will only apply to the serial ports assigned to that same group:

22.11.0	CONFIGURE Menu	128
---------	----------------	-----

The following table shows the effective rights for a user in one or both of those groups, *Accounts Admin* and *Port #03 User*:

Group Membership	<i>Accounts Admin</i>	<i>Port #03 User</i>	<i>Accounts Admin & Port #03 User</i>
Action			
Configure port-01	✓	✗	✓
Configure port-02	✓	✗	✓
Configure port-03	✗	✗	✗
Access port-01	✗	✗	✗
Access port-02	✗	✗	✗
Access port-03	✗	✓	✓

Note: Note the highlighted cell; a user with `pmsHELL` access to `port-03` (from the *Port #03* user group) does not also get `port_config` for that port, even though that access right is inherited from the *Accounts Admin* group. The access rights of a group *only apply to the serial ports in that same group*. This principle is illustrated in the following figure:

The figure below shows how access rights assigned to one group only apply to the serial ports assigned to that same group.

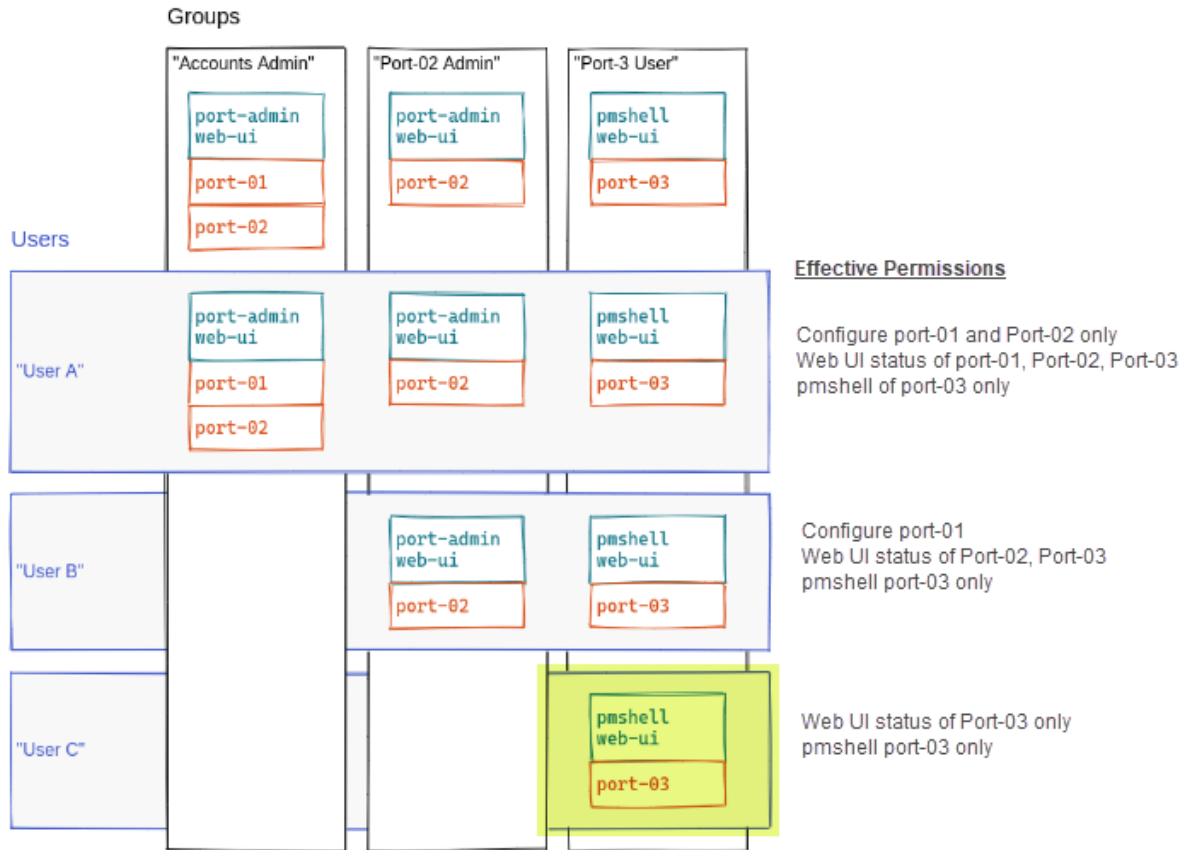

Create a New Group



1. Select **CONFIGURE > USER MANAGEMENT > Groups**.

GROUPS

Click to edit a group

Click to add a new group

NAME	DESCRIPTION	LOCAL MEMBERS	STATUS
admin	Provides users with unlimited configuration and management privileges	1	✔
netgrp	Group for users created automatically via network authentication	0	✘

	Add a new group.
admin	Click on the group name to edit an existing group.
Status <input type="checkbox"/> Enabled <input checked="" type="checkbox"/> Disabled	In the EDIT GROUP window - Enable/Disable an existing group.
Admin Access  <input checked="" type="checkbox"/> Enabled <input type="checkbox"/> Disabled	Grant admin access rights and full control of this console, and all attached devices, to all users of this group.
	Delete a group (or delete selected groups).

2. Click the **Add New Group** button. The **CREATE GROUP** page opens.

CREATE GROUP

Status
 Enabled Disabled

Name ⓘ

Description ⓘ

Admin Access ⓘ
 Enabled Disabled

ACCESS RIGHTS

NAME	DESCRIPTION
<input type="checkbox"/> Web UI	Permits access for an authenticated user to basic status information via the web interface and rest API.
<input type="checkbox"/> PM Shell (Restricted CLI)	Permits access to devices connected to serial ports.
<input type="checkbox"/> Missing translation: general.access_rights.rights.port_config	Missing translation: general.access_rights.rights.port_config_description

3. Enter a **Group Name**, **Description**, and set **Admin Access** to **Enabled** or **Disabled**. Specific access rights can be selected in the **ACCESS RIGHTS** area.

Note: **Group Name** is case sensitive. It can contain numbers and some alphanumeric characters. When using remote authentication, characters from a user's remote groups that are not allowed are converted to underscores during authentication. Local groups can be created that take that into account, allowing the authentication to continue.

Note: If **Admin Access** is Enabled, members of the group will have full access to and control of selected managed devices, and the rights that are selected under **ACCESS RIGHTS** for that group.

4. Select the applicable **Access Rights** for the group (see the below table).

22.11.0	CONFIGURE Menu	132
---------	----------------	-----

5. If the new group is to be activated immediately, set the group **Status** to **Enabled**.
6. Click the **Submit** button to save the group. After creation, group **Status** and **Admin Access** may be enabled or disabled from the **CONFIGURE > USER MANAGEMENT > Groups > EDIT GROUP** page.

Edit an Existing Group

1. Select **CONFIGURE > USER MANAGEMENT > Groups**.
2. Click on the name of the group to be modified and make desired changes.
3. Click **Submit** to save the changes

The **CONFIGURE > User Management > Groups** page also allows administrators to delete a group. Users who were members of the deleted group lose any access and administrative rights inherited from the group.

Note: The netgrp group is inherited as the primary group for all remote AAA users who are not defined locally. By default, netgrp has the Administrator role and is disabled. It must be enabled to take effect for remote AAA users.

Note: For users that don't have any group, they are still part of netgrp, even if the netgrp membership is not explicitly enabled for the user.

The permissions for the netgrp members is a union of the permissions that have been given in the netgrp AND the permission for the user in AAA (TACACS+, RADIUS, etc).



If your netgrp "role" says "Console User" and you have priv-lvl 13 in TACACS+ (level 15 being the highest), then the union of that is like an admin already, so setting "console user" in netgrp does not matter.

Local Users

[CONFIGURE > USER MANAGEMENT > Local Users](#)







The Local Users feature allows a single point for the creation or management of local user accounts. The Local Users feature can use SSH authorized keys to control user access by using their local password; it is a point of control for:

- Authentication and authorization.
- Creating and editing user descriptions.
- Local passwords.
- User roles (admin or co sole user).
- Accessible ports.

LOCAL USERS			
<input type="checkbox"/>	Username	Description	Actions
<input type="checkbox"/>	root	System wide SuperUser account	  

See the Button Action Definitions table on the following page:

Button Action Definitions:

	Add a new local user.
	Edit an existing user.
	Enable an existing user.
	Manage SSH Authorized Keys.
	Disable an existing user (or disable selected users).
	Delete a user (or delete selected users).

Create a New User With Password

1. Navigate to the **CONFIGURE > USER MANAGEMENT > Local Users** page.
2. Click the **Add User**  button. The **New User** dialog appears.
3. Enter a Username, Description, and Password that the new user will use.
4. Re-enter the **Password** in the **Confirm Password** field.
5. Select the **Enabled** checkbox.
6. Click **Apply**. A banner will confirm that the data has been saved.

Create a New User With No Password (Remote Authentication)

To create a new user with no password.

Note: If a new user is created with no password, this will cause the user to fall-back use remote authentication.

1. Select **CONFIGURE > User Management > Remote Authentication**
2. Select a Mode.
3. Enter Settings and click **Apply**.
4. Select **CONFIGURE > USER MANAGEMENT > Local Users**
5. Click the **Add User** button. The **New User** dialog loads.
6. Enter a **Username, Description**.
7. Select the **Remote PasswordOnly** checkbox.
8. Select the **Enabled** checkbox.
9. Click **Apply**. A banner will confirm that the data has been saved.

Modify An Existing User Account With Password



1. Select **CONFIGURE > USER MANAGEMENT > Local Users**
2. Click the **Edit User** button and make the required changes.
3. Click **Save User**. A banner will confirm the changes have been saved.

The **Edit Users** dialog allows the user's **Description** to be changed, **Group Memberships** modified, and the user's **Password** to be reset. The username cannot be changed. To disable a user, uncheck the **Enabled** checkbox.

Note: Users of disabled accounts cannot log in to the Operations Manager using either the Web-based interface or via shell-based logins.

Manage SSH Authorized Keys for a User Account

To manage SSH authorized keys for a user:

1. Select **CONFIGURE > USER MANAGEMENT > Local Users**
2. Click the **Manage SSH Authorized Keys**  button for that user.
3. Click the **Add Authorized Key**  button to add a new key. This opens the **NEW AUTHORIZED KEY** page for this user.

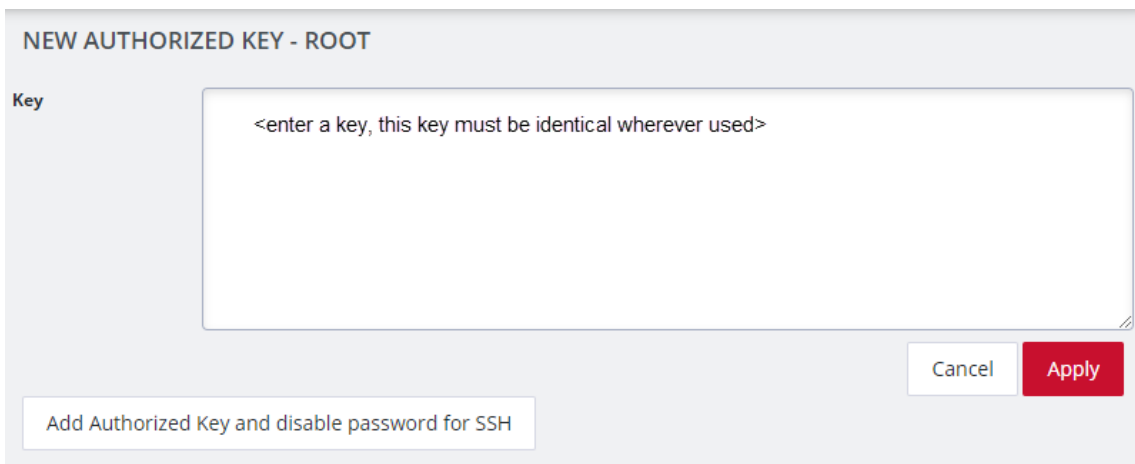

4. Enter the key and click **Apply**. You can also click on **Add Authorized Key** and disable password for SSH for this user from this page.
5. To delete a key, click **CONFIGURE > USER MANAGEMENT > Local Users** and click the **Manage SSH Authorized Key** button for the user.
6. Click the **Delete** button next to the key you wish to remove.

Delete a User's Account

To delete a user's account:

1. Select **CONFIGURE > USER MANAGEMENT > Local Users**
2. Click the **Delete User** button in the **Actions** section next to the user to be deleted.
3. Click **Yes** in the **Confirmation** dialog.

Remote Authentication

[CONFIGURE > USER MANAGEMENT > Remote Authentication](#)

The Operations Manager supports three AAA systems. Select the remote authentication mode to be applied (DownLocal, or Local apply for all modes):

- RADIUS
- TACACS+
- LDAP

Navigate to **CONFIGURE > USER MANAGEMENT > Remote Authentication**, the Remote Authentication Home page is displayed.

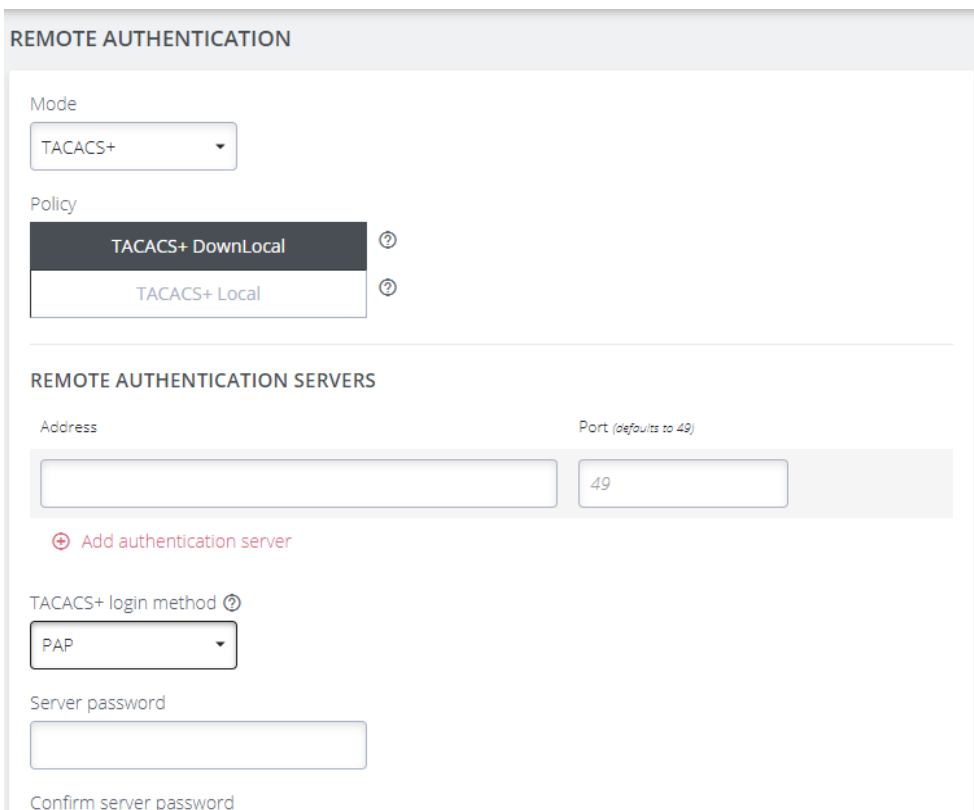

The screenshot shows the 'REMOTE AUTHENTICATION' configuration page. At the top, there is a 'Mode' dropdown menu set to 'TACACS+'. Below it is a 'Policy' section with two options: 'TACACS+ DownLocal' (highlighted) and 'TACACS+ Local'. The 'REMOTE AUTHENTICATION SERVERS' section contains an 'Address' input field and a 'Port (defaults to 49)' input field with the value '49'. There is a red '+' icon and the text 'Add authentication server'. Below this is a 'TACACS+ login method' dropdown menu set to 'PAP', a 'Server password' input field, and a 'Confirm server password' label.

Tip: All fields in the Remote Authentication form have tooltips that provide additional information to assist with completing the form fields.

Configure RADIUS Authentication

1. Under **CONFIGURE > User Management > Remote Authentication**, select **RADIUS** from the **Mode** drop-down menu.

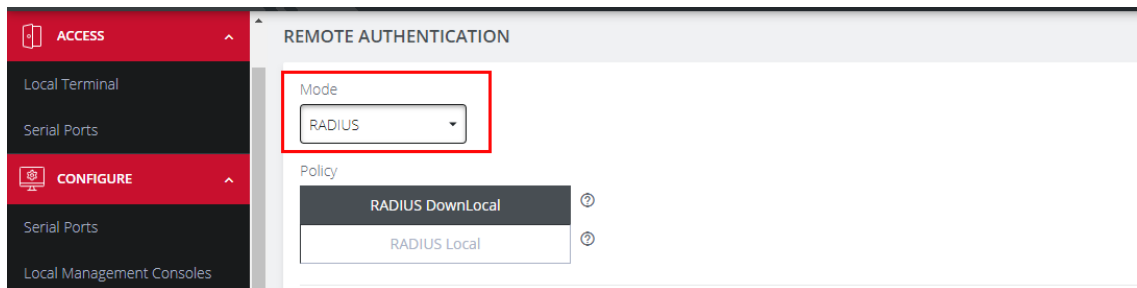

2. Select the preferred Radius Remote Authentication policy to be applied: **Radius DownLocal**, or **Radius Local** (see the tips below).

Tip: RADIUS DownLocal: Users are authenticated through their local account only if the remote AAA server is unreachable or down. If the credentials provided at login are incorrect or if the account does not exist on the remote server, the user is denied access.

Tip: RADIUS Local: If remote authentication fails because the user account does not exist on the remote AAA server, the OM attempts to authenticate the user using a local account as per a regular local login

3. Add the **Address** and optionally the **Port** of the authentication server.
4. Add the **Address** and optionally the **Port** of the RADIUS accounting server.
5. Add and confirm the **Server password**, also known as the RADIUS Secret.
6. Click **Apply**.

Note: Multiple servers can be added. The RADIUS subsystem will query them in a round-robin fashion.

To provide group membership, RADIUS needs to be configured to provide a list of group names via the Framed-Filter-Id attribute. The following configuration snippet shows how this can be configured for FreeRADIUS:

```
operator1 Auth-Type := System
Framed-Filter-ID = ":group_name=west_coast_admin,east_coast_user:"
```

Note: The Framed-Filter-ID attribute must be delimited by the colon character.

Configure TACACS+ Authentication

1. Under **CONFIGURE > USER MANAGEMENT > Remote Authentication**, select TACACS+ from the **Mode** drop-down menu.
2. Select the preferred TACACS+ Remote Authentication policy to be applied: **TACACS+ DownLocal**, or **TACACS+ Local** (see the tips below).

Tip: TACACS+ DownLocal: Users are authenticated through their local account only if the remote AAA server is unreachable or down. If the credentials provided at login are incorrect or if the account does not exist on the remote server, the user is denied access.

Tip: TACACS+ Local: If remote authentication fails because the user account does not exist on the remote AAA server, the OM attempts to authenticate the user using a local account as per a regular local login.

3. Add the **Address** and optionally the **Port** of the TACACS+ authentication server to query.

4. Select the **Login Method**. **PAP** is the default method. However, if the server uses DES-encrypted passwords, select **Login**.
5. Add and confirm the **Server password**, also known as the TACACS+ Secret.
6. Add the **Service**. This determines the set of attributes sent back by the TACACS+ server

Note: Multiple servers can be added. The TACACS+ subsystem queries them in a round-robin fashion.

```
user = operator1 {
    service = raccess {
        groupname = west_coast_admin,east_cost_user
    }
}
```

7. Enable or Disable **Remote Accounting**.

TACACS Accounting is enabled by default, the Remote Auth Server is used as the Accounting server. However one or more Accounting Servers can be specified.

- a. To disable Remote Accounting, select **Disable**
- b. To enable Remote Accounting, select **Enable**.

REMOTE ACCOUNTING

Enable Accounting Disable Accounting

Accounting logs for CLI and Console Port logins will be sent to the first available Remote Authentication Server.

8. Click **Apply**.

Note: For Cisco ACS, see [Setting up permissions with Cisco ACS 5 and TACACS+](#) on the Opengear Help Desk.

Configure LDAP Authentication

1. Under **CONFIGURE > User Management > Remote Authentication**, select **LDAP** from the **Mode** drop-down menu.
2. Select the preferred LDAP Remote Authentication policy to be applied: **LDAP DownLocal**, or **LDAP Local** (see the tips below for explanation).

Tip: LDAP DownLocal: Users are authenticated through their local account only if the remote AAA server is unreachable or down. If the credentials provided at login are incorrect or if the account does not exist on the remote server, the user is denied access.

Tip: LDAP Local: If remote authentication fails because the user account does not exist on the remote AAA server, the OM will attempt to authenticate the user using a local account as per a regular local login.

2. Add the **Address** and optionally the **Port** of the LDAP server to query.
3. Add the **LDAP Base DN** that corresponds to the LDAP system being queried.
For example:

```
CN=example-user, CN=Users, DC=example-domain, DC=com
```

4. Add the **LDAP Bind DN**. This is the distinguished name of a user with privileges on the LDAP system to perform the lookups required for retrieving the username of the users, and a list of the groups they are members of.
5. Input the password for the **LDAP Bind DN** user and confirm the password.

6. Add the **LDAP Username Attribute**. This depends on the underlying LDAP system. Use sAMAccountName for Active Directory systems, and uid for OpenLDAP based systems.
7. Add the **LDAP Group Membership Attribute**. This is only needed for Active Directory and is generally memberOf.
8. If desired, check **Ignore referrals** option. When checked, LDAP will not follow referrals to other remote authentication servers when logging users in. If multiple remote authentication servers exist on the network, checking this option may improve log in times.

Note: Multiple servers can be added. The LDAP subsystem queries them in a round-robin fashion.

Local Password Policy

[CONFIGURE > USER MANAGEMENT > Local Password Policy](#)

A Password Complexity policy allows network administrators to implement and enforce a password policy that meets the customers' security standards for local users (including root). This functionality enables administrators to mandate the setting of complex passwords thus making it difficult for malicious agents to succeed in password attacks.

Enabling this feature will:

- Enforce the use of complex passwords so as to improve security.
- Schedule expiry of passwords to enforce regular password updates.

Note: Password policy such as complexity and expiry can only be configured by an administrator. Password requirements are applied to all accounts.

Tip: Password policy may be enabled and configured via the Web GUI, rest-api and ogcli. The password policy also applies to underlying CLI tools.

Set Password Complexity Requirements

[CONFIGURE > USER MANAGEMENT > Local Password Policy](#)

Note: Some password complexity rules are required, other rules are optional. Optional rules can be selected by clicking on the relevant checkbox.

See also "[Password Policy Implementation Rules](#)" on page 148

To set the password complexity requirements:

1. Navigate to [CONFIGURE > USER MANAGEMENT > Local Password Policy](#).
2. Click the **Enforced** button to implement the password complexity policy (the policy is not activated until the **Apply** button is clicked).
3. Enter the information required to form the password complexity rules to comply with your company policy:
 - Password cannot be a palindrome (required)
 - Minimum length (required)
 - Must contain an upper case letter (optional)
 - Must contain a numeric character (optional)
 - Must contain a special character (non-alphanumeric eg. e.g. #,\$,%)
 - Disallow user names in passwords (optional)

See "[Password Policy Implementation Rules](#)" on page 148

4. Click the **Apply** button to activate the password complexity policy.

Set Password Expiration Interval

[CONFIGURE > USER MANAGEMENT > Local Password Policy](#)

See also "[Password Policy Implementation Rules](#)" on the next page

Password Expiration schedules the expiry of passwords to enforce regular password updates. When this feature is applied and a password becomes expired, an expired password prompt is displayed at log-in.

Note: The Password Expiration policy affects local passwords only and does not apply to remote authentication modes.

To set the password expiration interval:

1. Navigate to [CONFIGURE > USER MANAGEMENT > Local Password Policy](#).
2. Click the **Enabled** button to implement the password expiration policy (the policy is not activated until the **Apply** button is clicked).
3. Input a number to represent the desired number of days between mandatory password updates. The default time is 90 days and the minimum is 1 day.
4. Click the **Apply** button to activate the password interval policy.

Password Policy Implementation Rules

Rule	Policy
Expiry Rules	The expiry time is measured in number of whole days. When the expiry period is reached users are required to update their password on their next login. The default expiry period is 90 days and the minimum is one (1) day.
	If there are existing user passwords when the expiry is enabled, the expiry time will be applied from when the password was initially set by the user. If a password falls outside the new expiry period the user will be immediately prompted to change the password.
	Local Password policy is only applied to local passwords and does not apply to remote authentication modes.
	When local password policy is enabled it will remain in force until the feature is turned off.
	If the minimum password length is modified and then the password complexity feature is disabled, the minimum length requirement is not updated.
Complexity Rules	The password cannot be a palindrome (this requirement cannot be disabled except by disabling password complexity entirely). (A palindrome is a word or other sequence of characters that reads the same backward as forward, such as <i>madam</i> or <i>racecar</i>).
	The minimum length (enforced) must be at least 8 characters (this requirement cannot be disabled except by disabling password complexity entirely).
	The password should contain at least one upper case alphabetic character (enabled or disabled separately).

	<p>The password must contain at least one numeric character (enabled/disabled separately).</p>
	<p>The password should contain at least one special character (e.g. #,\$,%) (enabled/disabled separately).</p>
	<p>The password cannot contain your user-name.</p>
	<p>Complexity requirements will apply when a user next tries to update their password.</p>
	<p>An administrator can force the expiry of a users password by running the ogCLI command: <code>passwd --expire {username}</code> to force a user to change their password.</p>
	<p>The operations <code>ogadduser</code>, <code>ogpasswd</code> and <code>ogsshaddsshkey</code> have been removed. You should instead use ogCLI for these operations.</p>



Services

[CONFIGURE > SERVICES](#)

The **CONFIGURE > SERVICES** menu lets you manage services that work with the Operations Manager.

22.11.0	CONFIGURE Menu	150
---------	----------------	-----

Brute Force Protection

[CONFIGURE > SERVICES > Brute Force Protection](#)

A brute-force attack is an attempt to discover a password by systematically trying every possible combination of letters, numbers, and symbols until the one correct combination that works.

Brute Force Protection offers an essential defense mechanism by automatically blocking access from offending source IP addresses.

Caution: Brute Force Protection may prevent access to the system during an emergency.

Configure Brute Force Protection

Note: Brute Force Protection is enabled by default for SSH and Web UI.

To configure Brute Force Protection:

1. Navigate to **CONFIGURE > SERVICES > Brute Force Protection**.
2. Choose the desired settings as described below.
3. Click **Apply** to save the changes.

Field	Values	Description
SSH Protection	Enabled / Disabled	Enable Brute Force Protection for SSH login attempts.
HTTPS Protection	Enabled / Disabled	Enable Brute Force Protection for Web UI login attempts.

Field	Values	Description
Maximum failed attempts	Attempts: 3 (minimum) Time period in minutes: 1 (minimum)	The number of failed access attempts permitted within the given time period before preventing access.
Lockout period	60 (minimum)	The number of seconds that an IP address will be banned after violating the Brute Force Protection policies.

Viewing Current Bans

IP addresses that are currently blocked appear in the CURRENT BANS section of the Web UI, displaying the address and remaining duration of the ban or how long ago the ban was lifted.

Hover over the ban time for more detailed information.

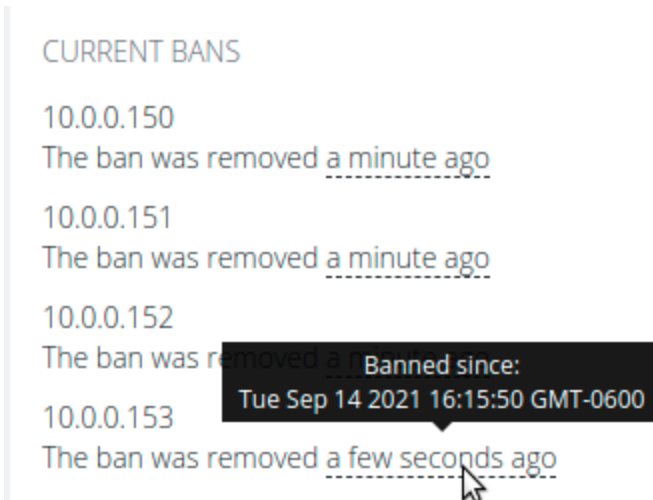

CURRENT BANS

10.0.0.150
The ban was removed a minute ago

10.0.0.151
The ban was removed a minute ago

10.0.0.152
The ban was removed a few seconds ago

10.0.0.153
The ban was removed a few seconds ago

Banned since:
Tue Sep 14 2021 16:15:50 GMT-0600

Managing Brute Force Protection via Command Line

For more control over Brute Force Protection, administrative users can use the command line to configure the service and remove bans manually.

22.11.0	CONFIGURE Menu	152
---------	----------------	-----

Description	Command	Notes
Display Brute Force Protection configuration	<pre>ogcli get services/brute_force_protection</pre>	
Update Brute Force Protection configuration	<pre>ogcli replace services/brute_force_protection << END ban_time=180 find_time=1 https_enabled=false max_retry=4 ssh_enabled=true END</pre>	Ban time in seconds. Find time in minutes.
Un-ban an IP address	<pre>fail2ban-client unban <ipaddress></pre>	
Un-ban all current bans	<pre>fail2ban-client unban --all</pre>	
List SSH bans	<pre>fail2ban-client status sshd</pre>	SSH protection must be enabled
List HTTPs bans	<pre>fail2ban-client status https</pre>	HTTPs protection must be enabled
List all bans with ogcli	<pre>ogcli get monitor/brute_force_protection/bans</pre>	

HTTPS Certificate

[CONFIGURE](#) > [SERVICES](#) > [HTTPS Certificate](#)

The Operations Manager ships with a private SSL Certificate that encrypts communications between it and the browser.

To examine this certificate or generate a new Certificate Signing Request, select **CONFIGURE > SERVICES > HTTPS Certificate**. The details of the **Current SSL Certificate** are shown on the landing page.

CURRENT SSL CERTIFICATE

Common Name 

default

The group overseeing this device.

Tool tips assist with completing the form

Organizational Unit 

Organization 

Locality/City 

State/Province 

Country 

US

Email 

Key Length (bits) 

2048

Issue Date 

Apr 26 20:11:11 2021 GMT

Expiry Date 

Apr 27 20:11:11 2022 GMT

Below this listing is a **Certificate Signing Request** form, which can be used to generate a new SSL certificate. Complete the form, then click **Apply**.

22.11.0	CONFIGURE Menu	154
---------	----------------	-----

CERTIFICATE SIGNING REQUEST

Common Name [?](#)

The group overseeing this device.

Tool tips assist with completing the form content

Organizational Unit [?](#)

Organization [?](#)

Locality/City [?](#)

State/Province [?](#)

Country [?](#)

Email [?](#)

Key Length (bits) [?](#)

Challenge Password [?](#)

Confirm Password [?](#)

Private Key File [?](#)

 No file chosen

Network Discovery Protocols

[CONFIGURE > SERVICES > Network Discovery Protocols](#)

The Operations Manager displays LLDP/CDP Neighbors when enabled for a connection. See **CONFIGURE > SERVICES > Network Discovery Protocols** to enable/disable.

The **CONFIGURE > SERVICES > Network Discovery Protocols > LLDP/CDP NEIGHBORS** page allows you to enable this service by clicking the **Enabled** checkbox.

You can set a System Description that overrides the default system description sent by the network discovery protocol daemon. The default description is the kernel name, the node name, the kernel version, the build date and the architecture.

A value can be entered in the CDP Platform Override to override the CDP platform name. The default name is the kernel name (Linux).

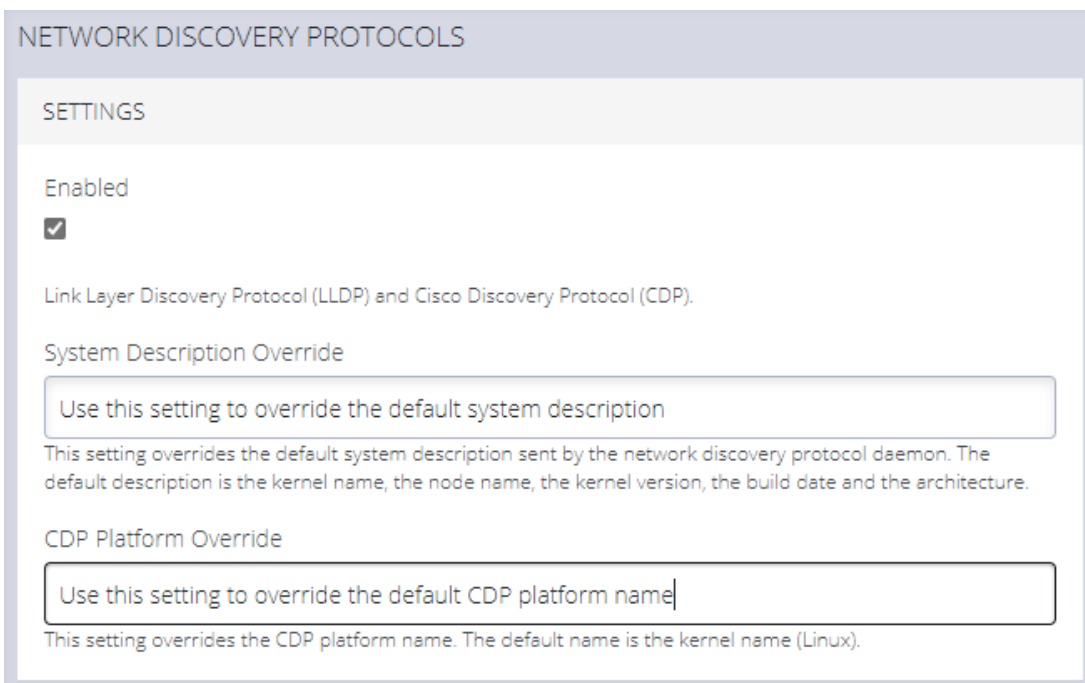

NETWORK DISCOVERY PROTOCOLS

SETTINGS

Enabled

Link Layer Discovery Protocol (LLDP) and Cisco Discovery Protocol (CDP).

System Description Override

Use this setting to override the default system description

This setting overrides the default system description sent by the network discovery protocol daemon. The default description is the kernel name, the node name, the kernel version, the build date and the architecture.

CDP Platform Override

Use this setting to override the default CDP platform name

This setting overrides the CDP platform name. The default name is the kernel name (Linux).

Select one or more checkboxes in the **NETWORK INTERFACES** section of the page and click **Apply**.

NETWORK INTERFACES

Selecting an interface allows LLDP/CDP monitoring for that interface.

NET1 - 1G Copper/SFP

NET2 - 1G Copper/SFP

Apply

Routing

[CONFIGURE > SERVICES > Routing](#)

The Operations Manager supports Static Routing and Dynamic Routing. Static Routing is currently configured via the ogcli interface, while Dynamic Routing is configured via the UI.

Dynamic Routing

To enable Dynamic Routing on the OM, navigate to the **CONFIGURE > SERVICES > Routing** page.

Dynamic Routing supports four routing protocols, these are:

- BGP (Border Gateway Protocol)
- OSPF (Open Shortest Path First Protocol)
- IS-IS (Intermediate System to System Protocol)
- RIPD (Routing Information Protocol)

Select the preferred routing protocol then click **Apply**.

Note: If no protocol is selected, no route sharing services are run on the OM.

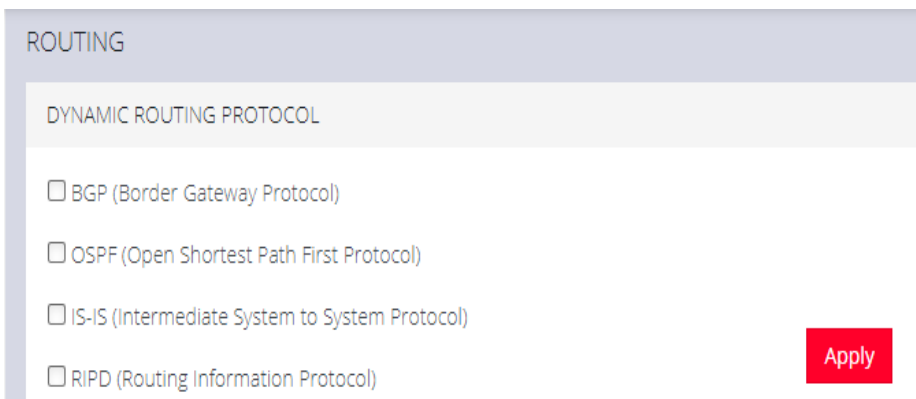

Static Routing (via the ogcli)

To enable Static Routing on the OM, open an ogcli terminal by navigating to **ACCESS > Local Terminal**.

Static Routing ogcli Help

For Help on implementing a Static Route protocol via ogcli, enter the command:

```
ogcli help static_routes
```

Create Static Route - Example:

```
ogcli create static_route << 'END'  
destination_address="10.1.45.0"  
destination_netmask=24  
gateway_address="192.168.1.1"  
interface="system_net_physifs-1"  
metric=100  
  
END
```

Static Routing Arguments

Argument	Description
<code>get</code>	Get a list of static routes.
<code>create</code>	Add a static route.
<code>replace</code>	Similar to the "Create Static Route" example given on the previous page. Creates a single static route by specifying its UUID; or a list of static routes. Overwrites existing routes.
<code>delete</code>	Delete all static routes.
<code>merge</code>	Merge the existing configuration list with a new list.

SSH

[CONFIGURE > SERVICES > SSH](#)

To modify the properties of the port used for connecting to serial consoles via SSH, navigate to **CONFIGURE > SERVICES > SSH** .

The following table gives the definitions of the configurable SSH properties.

Parameter	Definition
Serial Port Delimiter	The delimiting character used to separate the username with port selection information. The default delimiter is a plus sign (+). For example, username+port@address.
Port Number for Direct SSH Links	If SSH is configured to be reachable on a non-standard port, the Direct SSH links on the serial ports page will use this port number.
Max Startups Start	The number of unauthenticated connections before they are refused.
Max Startups Rate	This is the percentage of unauthenticated connections refused. This percentage is a probability that increases linearly until the unauthenticated connections reach full.
Max Startups Full	The number of unauthenticated connections allowed.

Unauthenticated Access to Serial Ports

For information about Unauthenticated Access to Serial Ports, see

["Unauthenticated SSH to Serial Ports" on the next page.](#)

Unauthenticated SSH to Serial Ports

[Configure](#) > [Services](#) > [SSH](#)

The Unauthenticated SSH Access feature provides the option to access console ports (using TCP high ports) by establishing per-port SSH connection between a console and serial ports at a remote device. This allows a single step log-in and avoids the necessity for two log-ins to reach a remote end device within secure, closed networks.

Usually, you would need to authenticate on the Opengear appliance, followed by any log in to a device you are connecting to via the serial port.

When unauthenticated access is enabled SSH is available to all serial ports on the device without requiring a password.

Note: Unauthenticated access can be used with or without IP aliases for serial ports.

Caution: For security, **Unauthenticated SSH** should only be used when operating within a trusted, closed network, for example within a lab. There is a security risk in allowing any kind of unauthenticated access to serial ports and any terminals connected to them.

Enable Unauthenticated SSH

Authenticated or Unauthenticated access is determined via a global configuration option. Unauthenticated access to individual ports is achieved by command such as `ssh -p 300X user@<IP>`.

Enable SSH

Note: This feature may be enabled using the default settings without the need for configuration.

1. Open the SSH form, **Configure > Services > SSH > SSH (form)**.
2. Complete the SSH form (if this is the first time Unauthenticated SSH has been used), a description of the input data is provided at "[Properties and Settings](#)" on page 165 in this topic.
3. When required, enable the Unauthenticated SSH feature by clicking the **Enabled** button.

Note: Unauthenticated access to all serial ports will be available through SSH on TCP port 3000+ or Serial Port IP aliases.

Enable/Disable

Enabling or disabling this feature is done in the user interface.

To **enable** the feature click on the **Enabled** button then click the **Apply** button. The feature is enabled immediately and a pop-up will confirm that the feature is enabled.

Note: Clicking the **Apply** button saves any changes you have made to the SSH form. A Details Saved banner confirms that the changes have been saved.

To **disable** the feature click on the **Disabled** button then click the **Apply** button. There is no confirmation pop-up when the feature is disabled.

Connecting Directly to Serial Ports

For ports that have been configured with the SSH access service, you can connect directly to a port and start a session, bypassing the chooser, by using one of the four conventions described in the following:

Convention	Example
Use a network client to connect to the service network Base Port + serial port number.	<pre># SSH to serial port 1 by TCP port ssh -p 3001 -l operator 70.33.235.190</pre> <p>In this example, the SSH base port is TCP port 3000, so SSH to TCP port 3001 directly connects you to serial port 1</p>
SSH to the Opengear node, log in adding :portXX to your username (e.g. root:port01 or operator:port01)	<pre># SSH to serial port labelled Router ssh -l operator:Router 70.33.235.190</pre>
SSH to the Opengear node, log in adding the :port-label to your username (e.g. root:Router or operator:Router)	<pre># SSH to serial port 1 by port name ssh -l operator:port01 70.33.235.190</pre>
Configure per-port IP aliases	

Note: For additional reading on connecting to serial ports see:

<https://opengear.zendesk.com/hc/en-us/articles/216373543-Communicating-with-serial-port-connected-devices>

Note: Serial ports in the Local Console and Disabled ports modes are not available for SSH connection.

Feature Persist

If the node has an active console session after closing pmsheel, connecting to the node again will resume the session and you are not prompted for the node password.

Properties and Settings

Property	Definition/Range
Serial Port Delimiter	<p>A character that separates the User name and port selection information. The default value is the + character.</p> <p><i>Default is '+', maximum length is 1.</i></p> <p><i>The prohibited characters are '\', ' ', '`', ' ', '=', and '#'.</i></p> <p>Source: schema</p> <pre>required ssh_delimiter: string (default = "+"; minimum = 1; maximum = 1; validator = ("ssh_url_ delimiter")),</pre> <p>Source: validator</p> <pre>if (strlen(v) != 1) valid = 0; else if (v[0] == '\') valid = 0;</pre>

	<pre> else if (v[0] == "") valid = 0; else if (v[0] == "'") valid = 0; else if (v[0] == ' ') valid = 0; // breaks sshd_config else if (v[0] == '=') valid = 0; // breaks sshd_config else if (v[0] == '#') valid = 0; // breaks sshd_config else if (!isprint(v[0])) valid = 0; else { valid = 1; } </pre>
Port Number for Direct SSH Links	This port number will be used for direct SSH links on the serial ports page. Set this option if you have configured SSH to be reachable on a non-standard port.
Max Startups Start	The number of connections pending authentication before new connections <i>begin</i> to be refused. <i>Required start: int (minimum = 1; default = 10)</i>
Max Startups Full	The number of connections pending authentication before <i>all</i> new connections are refused. <i>Required full: int (minimum = 1; default = 100)</i>
Max Startups Rate	This is the percentage rate at which new

	<p>connections are refused once the Max Startups value is reached. The rate is increased to 100% at Max Startup Full.</p> <p><i>Required rate: int (minimum = 1; maximum = 100; default = 30),</i></p> <p><i>The rate at which connections are refused randomly begins at max startup rate and increases linearly until the number of connections pending authentication reach max startups full, in which case 100% of new connections are refused.</i></p>
Unauthenticated Access to Serial Ports	This is the feature Enable/Disable button.

Syslog

[CONFIGURE > SERVICES > Syslog](#)

Administrative users can specify multiple external servers to which the Syslog can be exported via TCP or UDP. There is a drop-down on each serial port to enable the logging and to define the “scope” of logging.

The Syslog page lists any previously added external syslog servers. See also *Remote Syslog* in this User Guide.

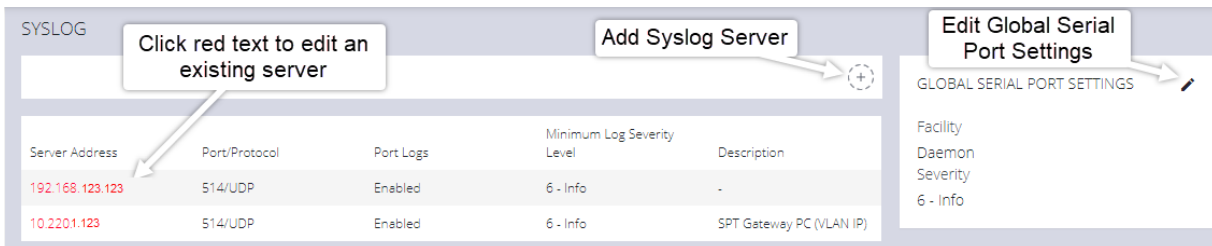

Server Address	Port/Protocol	Port Logs	Minimum Log Severity Level	Description
192.168.123.123	514/UDP	Enabled	6 - Info	-
10.2201.123	514/UDP	Enabled	6 - Info	SPT Gateway PC (VLAN IP)

Add a New Syslog Server

Note: The combination of server address, protocol and port should be unique. There can be no duplicates. However, the same server could be used if the other entry is an IPv6 address to the same Syslog server.

Use the following procedure to add a new Syslog Server.

1. Navigate to **CONFIGURE > SERVICES > Syslog**.
2. Click the **Add Syslog Server** button. The **Add Syslog Server** form opens.
3. In the **Description** field, add a suitable description that will help to identify the new server.
4. Enter the **Server Address**.
5. Click the **Protocol** switch to select either **UDP** or **TCP**.

6. Enter the correct **Port**. If no port is entered, UDP defaults to port 514 and TCP defaults to 601.
7. From the drop-down list, select the required severity level to be logged, eight levels of log severity are supported.

Note: This configuration acts as a filter, such that any log equivalent or higher will be sent to the remote Syslog server.

8. Click **Add** to complete the process.

Global Serial Port Settings

Global Serial Port Settings will define the Facility used and the Severity of all Syslog serial port activity sent from this node. There are two setting functions, Facility, and Severity. From the drop-down menus, select the preferred Facility and Severity as required.

For definitions of Facility and Severity, see **Syslog Facility Definitions** and **Syslog Severity Definitions** in the **Remote Syslog** topic.

Edit or Delete an Existing Syslog Server

To edit an existing syslog server, click the hyperlinked **Red Text** server name in the server list (see the Syslog page image on the previous page). Make the required changes, then click the **Submit** button.

Delete a server by clicking the Delete icon at the top-right of the **Edit Syslog Server** page.

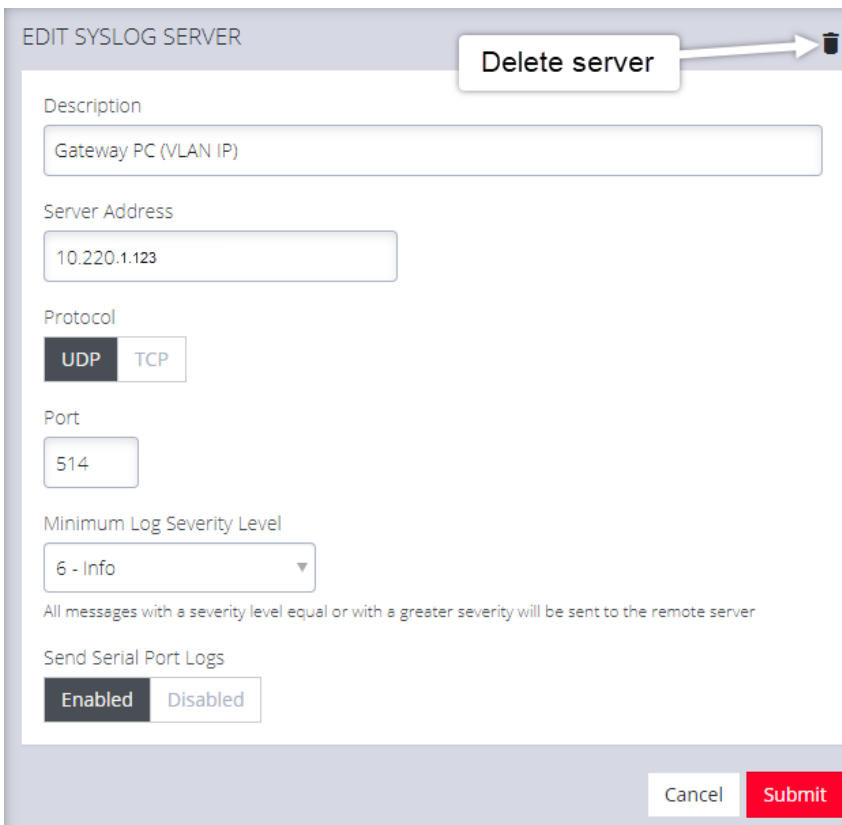

EDIT SYSLOG SERVER

Delete server

Description
Gateway PC (VLAN IP)

Server Address
10.220.1.123

Protocol
UDP TCP

Port
514

Minimum Log Severity Level
6 - Info

All messages with a severity level equal or with a greater severity will be sent to the remote server

Send Serial Port Logs
Enabled Disabled

Cancel Submit

Session Settings

[SETTINGS](#) > [SERVICES](#) > [Session Settings](#)

Use **Session Settings** to set timeouts for console sessions where the users have been idle for a specified time. At timeout, the user's web, CLI or Serial Port sessions are terminated, thus excluding authorized users with physical access to the node that has been left connected.

To set the timeouts for Web, CLI or Serial Port sessions settings, navigate to the **SETTINGS > Services > Session Settings** page.

SESSION SETTINGS

Web Session Timeout
 minutes

CLI Session Timeout
 minutes
Set to 0 to disable.

Serial Port Session Timeout
 minutes
Set to 0 to disable.

[Apply](#)



- **Web Session Timeout:** Set the timeout from 1 to 1440 minutes.
- **CLI Session Timeout:** Set the timeout from 1 to 1440 minutes or set it to 0 to disable the timeout. Changes take effect the next time at the next login via the CLI.
- **Serial Port Session Timeout:** Set the timeout from 1 to 1440 minutes or set it to 0 to disable the timeout.

Click the **Apply** button to save the settings.

The new session timeout will take immediate effect on all pmsHELL sessions, including ones in use.

22.11.0	CONFIGURE Menu	172
---------	----------------	-----

File Server

[CONFIGURE > SERVICES > File Server](#)

The Operations Manager can be configured to serve files to clients via Trivial File Transfer Protocol (TFTP).

TFTP can be used by nodes on the network to perform a network boot, or to allow backup and restore of configuration files.

Note: Limitations

- The user is responsible for disk space management.
- User permissions cannot be set on files at this time.

Enable TFTP Service

Note: The TFTP service is disabled by default.

To enable the TFTP service:

- Click the **TFTP Enabled** button.



- Click **Apply** to save the changes.
- The TFTP service is now running with a default location of `/mnt/nvram/srv`.

This location is where all files uploaded to the TFTP server will be stored.

Note: The disk space usage information displayed on the page indicates the usage of the whole storage volume.

Modify Firewall Zones To Allow The TFTP Service To Be Used

The TFTP service must be allowed through a firewall zone so that clients may upload and retrieve files.

- Navigate to the Firewall Management page via **CONFIGURE > FIREWALL > Management**.
- Expand the desired firewall zone and click the **Edit Zone** button.
- Allow the "tftp" service from the list of Permitted Services.

Permitted Services

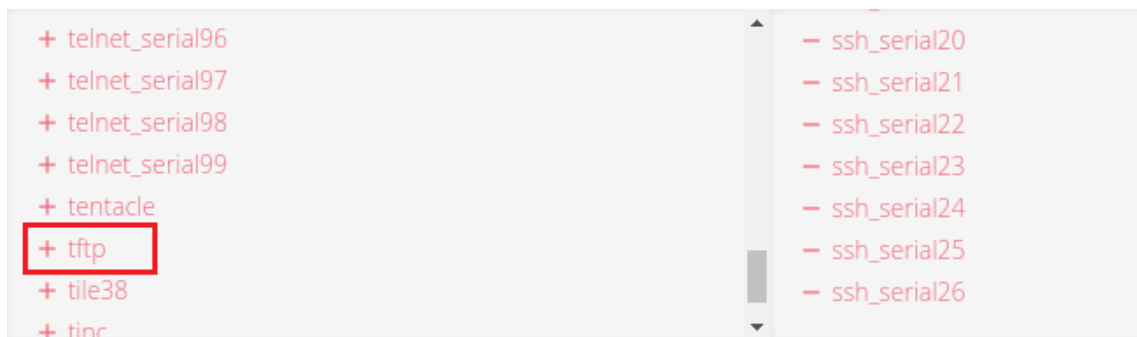

- Click **Apply** to save the changes.
- On the File Server page, the zones with TFTP enabled are now displayed.

ZONES WITH TFTP ENABLED

LAN , WAN

Update The TFTP Service Storage Location

The location used by the TFTP service can be updated using the **ogcli** tool.

Note: The storage location must be an existing directory before running ogcli update.

Caution: Using a storage volume other than **/mnt/nvram** is not recommended. Data may be lost after reboot, or be inaccessible when switching boot slots.

- As an administrative user, run:

```
ogcli update services/tftp path=\"<new path>\"
```

SNMP Service

[CONFIGURE > SNMP > SNMP Service](#)

Navigate to the **CONFIGURE > SNMP > SNMP Service** to open the **SNMP Service** page.

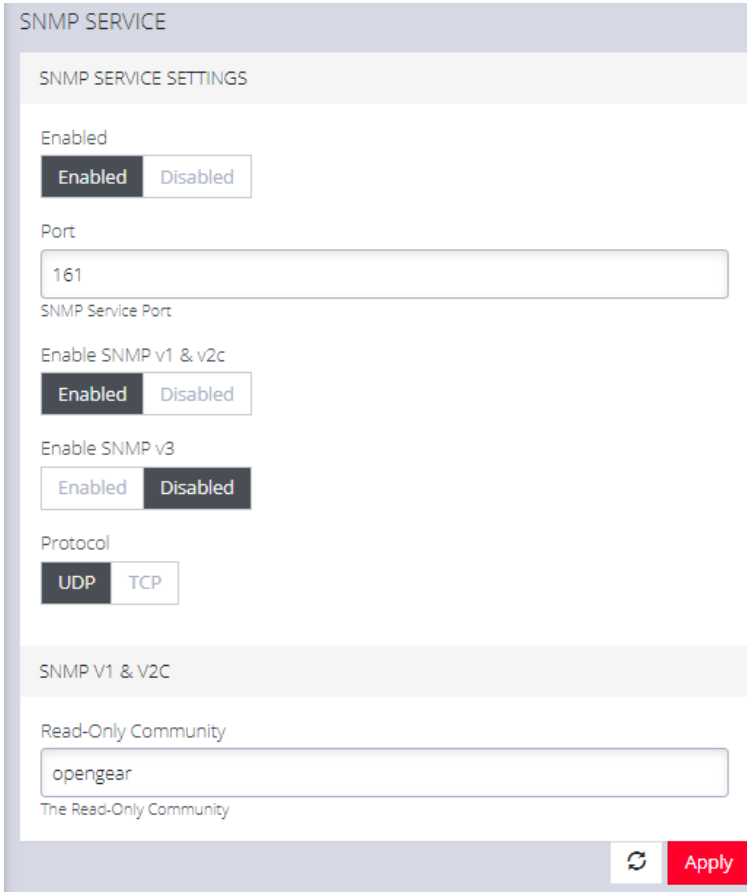

The screenshot shows the 'SNMP SERVICE' configuration page. It is divided into two main sections: 'SNMP SERVICE SETTINGS' and 'SNMP V1 & V2C'. In the 'SNMP SERVICE SETTINGS' section, there are several controls: a toggle for 'Enabled' (set to 'Enabled'), a text input for 'Port' (containing '161'), a toggle for 'Enable SNMP v1 & v2c' (set to 'Enabled'), a toggle for 'Enable SNMP v3' (set to 'Disabled'), and a toggle for 'Protocol' (set to 'UDP'). The 'SNMP V1 & V2C' section contains a text input for 'Read-Only Community' (containing 'opengear'). At the bottom right of the form, there is a refresh icon and a red 'Apply' button.

SNMP Service allows you to specify which SNMP services to enable. When you click on **ENABLED** for **SNMP V1 & V2** or **SNMP V3**, a detail form appears where you can add service specific settings.

You can also specify the **SNMP Service Port** and choose between **UDP** or **TCP** for the **Protocol**.

SNMP Alert Managers

[CONFIGURE > SNMP > SNMP Alert Managers](#)

Navigate to **CONFIGURE > SNMP > SNMP Alert Managers** to open the **SNMP Alert Managers** page.

See the "[Multiple SNMP Alert Managers](#)" on the next page feature for information about configuring more than one SNMP manager.

On this page, you can set the following:

- **Address:** The IPv4 Address or domain name of the computer acting as the SNMP Manager.
- **Version:** The version of SNMP to use. The default is v2c.
- **Port:** The listening port used by the SNMP Manager. The default value is 162.
- **Manager Protocol:** The transport protocol used to deliver traps to the SNMP Manager. The default value is UDP.
- **SNMP Message Type:** The type of SNMP message to send to the SNMP manager. The INFORM option will receive an acknowledgment from the SNMP manager and will retransmit if required. The TRAP option does not expect acknowledgments.

For SNMP V1 & V2C, you can specify a **Community**. This is a group name authorized to send traps by the SNMP manager configuration for SNMP versions 1 and 2c. This must match the information that is setup in the SNMP Manager. Examples of commonly used values are log, execute, net and public.

Multiple SNMP Alert Managers

[CONFIGURE > SNMP > SNMP Alert Managers > Add New SNMP Alert Manager](#)

The Multiple SNMP Alert Managers feature provides the option to configure more than one SNMP manager. Multiple SNMP Alert Managers can receive trap and inform events that can be used to trigger remedial action; events can be sent to multiple SNMP Alert Managers. The AR functionality sends traps to all configured SNMP Alert Managers for a reaction of type SNMP. Whether you input an IPv6 address or a domain name, the correct protocol needs to be selected.

Create or Delete an SNMP Manager

To create a new SNMP manager:



1. Navigate to **Configure > SNMP > SNMP Alert Managers**.
2. Click the **Add New SNMP Manager** button (a plus character in the top-right of the window)
3. Complete the new **SNMP Alert Manager Form** as per the **Definitions** table below.
4. Click the **Submit** button. A banner appears confirming that the new SNMP Manager has been successfully created.
5. The new manager appears in the list of SNMP Alert Managers.
6. To delete an SNMP manager, click on the IP address of the item to open the **Edit SNMP Manager** page for that SNMP Manager.
7. Click on the **Delete SNMP Manager** widget in the top-right of the page.

Note: If you would like to use an IPv6 Address, then you need to select either UDP6 or TCP6 from the list of protocols. Whether you input an IPv6 address or a domain name, the correct protocol needs to be selected.

Note: For SNMP V3 TRAPS, an Engine ID will be provided by default if none is specified. This is generated by the snmpd service and can be found in the SNMPD RUNTIME CONF `/var/lib/net-snmp/snmpd.conf`. Traps will be sent for Alerts added in **Configure > SNMP Alerts**. Traps will also be sent to all the configured SNMP Alert Managers for a Playbook SNMP Reaction.

New SNMP Alert Manager Page Definitions

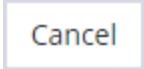
New SNMP Alert Manager Field	Definition
Description	The editable Description field allows you to add a description of the SNMP Alert Manager.
Server Address	The IPv4/IPv6 address or domain name of the computer acting as the SNMP Alert Manager.
Port	The listening port used by the SNMP Alert Manager. The default value is 162.
Protocol	<p>The transport protocol used to deliver traps or informs (for SNMP v3).</p> <p>UDP - Speeds up transmissions by enabling the transfer of data before an agreement is provided by the receiving party.</p> <p>TCP - A commonly used protocol used to transmit data from other higher-level protocols that require all transmitted data to arrive.</p> <p>UDP6 - Similar to UDP but uses IPv6.</p> <p>TCP6 - Similar to TCP but uses IPv6.</p>

Version	<p>The version of SNMP protocol to use. The default value is v2c. For further reading on SNMP versions we suggest:</p> <p>https://en.wikipedia.org/wiki/Simple_Network_Management_Protocol#Protocol_versions</p>
SNMP V1 & V2C Community	<p>A group name authorized to send traps by the SNMP alert manager configuration for SNMP versions 1 and 2c. This will need to match what is setup in the SNMP alert manager. Examples of commonly used values are log, execute, net and public.</p>
 	<p>Click the Submit button to finalize the New SNMP Manger process.</p>
	<p>Click the bin widget to Delete an SNMP Manager (in the Edit SNMP Manager page).</p>

Firewall

[CONFIGURE > FIREWALL](#)

In the **CONFIGURE > FIREWALL** menu you can configure:

- **Firewall Management**
- **Interzone Policies**
- **Services**

Firewall Management

[CONFIGURE > FIREWALL > Management](#)

Navigate to the Firewall Management page, **CONFIGURE > FIREWALL > Management**, from here you can:

- Add a new firewall zone.
- Add a firewall service.
- Edit a firewall zone - manage the zone setup.
- Manage port forwarding.
- Manage custom rules for firewalls.

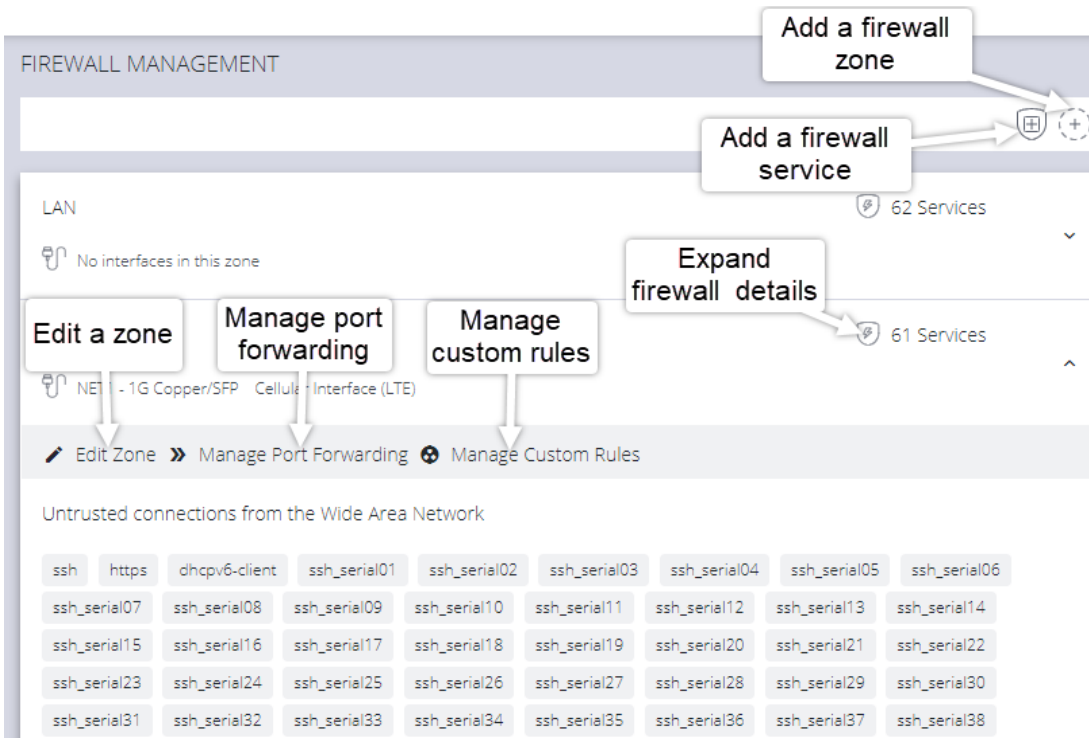

Figure: Firewall Management main page

Firewall Zone Settings

To change firewall management settings navigate to **CONFIGURE > FIREWALL > Management**.

You can inspect details of any zone by clicking the **Expand** icon to the right of the zone. Once expanded, you can click **Edit Zone** to change settings for a particular zone.

The **Edit Zone** page has three tabs. The **ZONE SETUP** page allows you to:

- Modify the Name of the zone.
- Add a Description for this zone.
- Permit all Traffic.
- Masquerade Traffic.
- Select Physical Interfaces.
- Manage Permitted Services by clicking on Plus or Minus next to each.

Tip: You can use the **Filter Interfaces** and **Filter Available Services** text boxes to limit the list content that is displayed.

Port Forwarding

The **MANAGE PORT FORWARDING** tab allows you to add, edit, and delete forwarding rules for the particular zone you are editing.

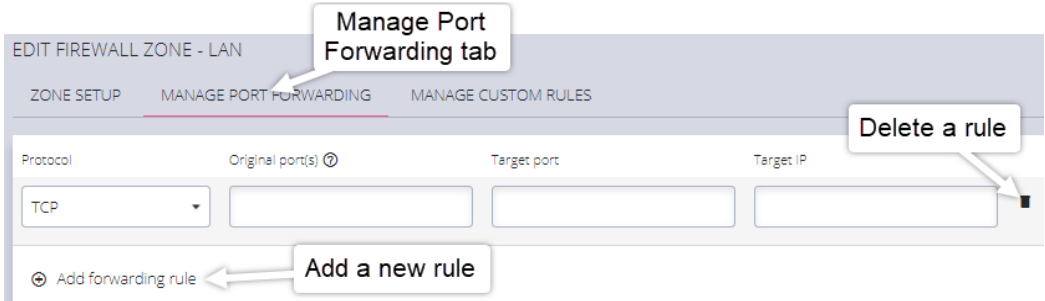

Manage Custom Rules

The third tab, **MANAGE CUSTOM RULES**, allows you to add, edit, and delete custom firewall rules for the zone you are editing. These custom rules continue to exist after reboots, upgrades, and power cycles.

These rules are prioritized by the order they are added.

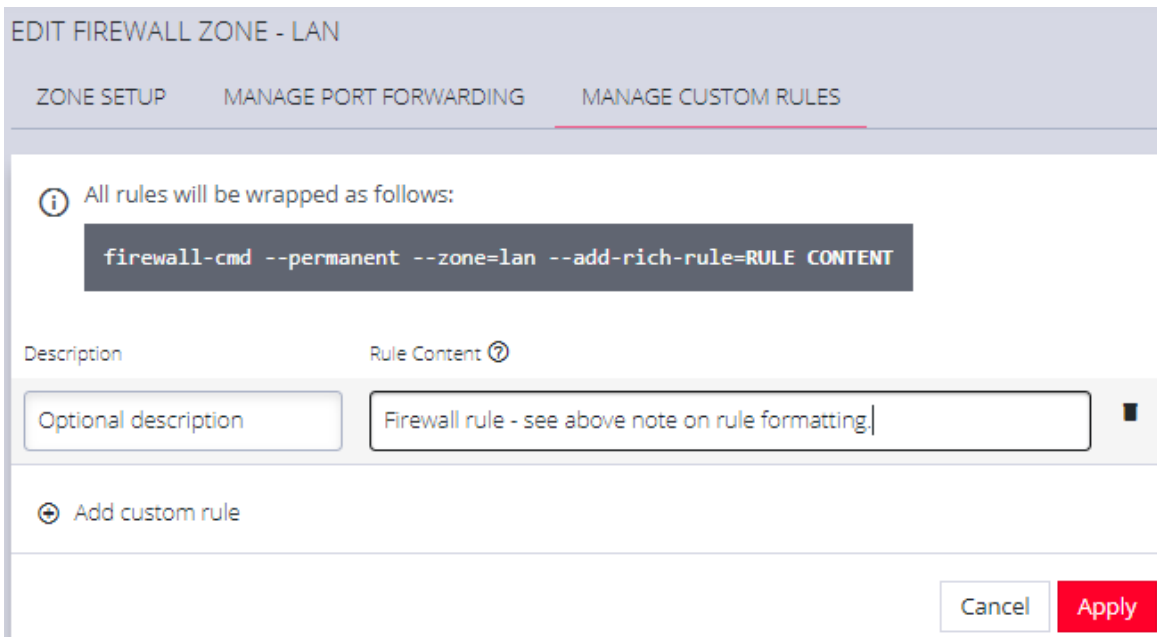

EDIT FIREWALL ZONE - LAN

ZONE SETUP MANAGE PORT FORWARDING **MANAGE CUSTOM RULES**

i All rules will be wrapped as follows:

```
firewall-cmd --permanent --zone=lan --add-rich-rule=RULE CONTENT
```

Description Rule Content *?*

Optional description Firewall rule - see above note on rule formatting

+ Add custom rule

Cancel **Apply**

To add a new custom rule:

1. Click **Add custom rule**.
2. Enter an optional description for this rule.
3. Enter the rule content, custom rule content formatted with firewall-cmd syntax.
4. Click **Apply**.

Note: All rules will be wrapped as follows:

```
firewall-cmd --permanent --zone=lan --add-rich-rule=RULE CONTENT
```

Interzone Policies

[CONFIGURE > FIREWALL > Interzone Policies > Create Interzone Policy](#)

In the Operations Manager, Interzone firewall policy is implemented through FirewallD; this is a zone-based firewall which allows you to define zones and create rules to manage the traffic between the zones.

The firewallD feature provides a dynamically managed firewall with support for network/firewall “zones” to assign a level of trust to a network and its associated connections, interfaces or sources.

The feature allows you to define policies to configure forwarding between zones and can be configured to allow directional forwarding from one or more ingress zones to one or more egress zones.

Rules and filtering may be applied at the zone level. When you add a zone, you select which services are part of that zone. Interzone policy allows these rules and filtering to be applied so as to control the type of traffic allowed to be forwarded.

The default policy, ie. when no zones are added, is that no traffic is forwarded.

Create an Interzone Policy

[CONFIGURE > FIREWALL > Interzone Policies > New Interzone Policy](#)

1. Navigate to the **Interzone Policies** page: [CONFIGURE > FIREWALL > Interzone Policies](#).
2. Click the **Add Firewall Policy** button  , the **New Interzone Policy** page opens for editing.
3. In the **Name** field, enter a name that clearly identifies this policy instance to other users.

4. In the **Description** field provide a detailed description of this interzone policy (optional).
5. Click to check the boxes for each Ingress and Egress zone that is to be included in this policy. You can configure traffic in both directions by selecting both zones in the Ingress and Egress as indicated by the red arrows in the image below:

Two Directional Traffic Interzone Policy:

INGRESS ZONES	EGRESS ZONES
<small>Traffic originating from the ingress zones will be allowed to forward to the egress zones.</small>	<small>The egress zones specify the list of zones that traffic will be forwarded to in this policy.</small>
<input type="checkbox"/> Select All Zones	<input type="checkbox"/> Select All Zones
<input checked="" type="checkbox"/> LAN	<input checked="" type="checkbox"/> LAN
<input checked="" type="checkbox"/> WAN	<input checked="" type="checkbox"/> WAN
<input type="checkbox"/> Lighthouse VPN	<input type="checkbox"/> Lighthouse VPN

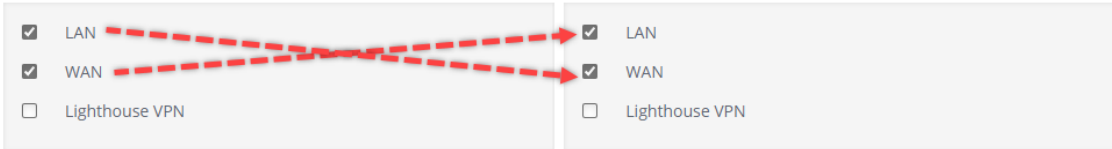

Note: Additional zones may be added to the zones list at: [CONFIGURE > FIREWALL > Management > New Firewall Zone](#).
Zone customized rules may be edited at [CONFIGURE > FIREWALL > Management > Firewall Management](#).

6. Click the **Apply** button to implement the policy, a green banner will inform you that the policy details are saved successfully. The interzone policy is now active.

Edit or Delete an Interzone Policy

[CONFIGURE > FIREWALL > Interzone Policies > Edit Interzone Policy](#)

1. Navigate to the **Interzone Policies** page: [CONFIGURE > FIREWALL > Interzone Policies](#).
2. Click the name of the policy you wish to edit (editable policies are identified by **red text**). The **Edit Interzone Policy** page opens for editing.
3. Edit the policy details to be changed.
4. If necessary, change the the **Description** field to provide a detailed description of the edited interzone policy.
5. To **delete** a policy, click on the **Bin** widget in the top-right corner of the **Edit** page.

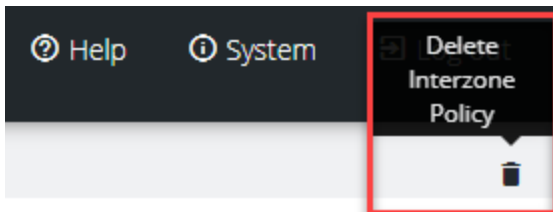

- 6.
7. Click the **Apply** button to implement the edited policy, a green banner will inform you that the policy details are saved successfully. The edited interzone policy is now active.

Customized Zone Rules

Customized zone rules may be applied to any zone at [CONFIGURE > FIREWALL > Management > Firewall Management: "Firewall Management"](#) on page 182.

System

CONFIGURE > SYSTEM

The **CONFIGURE > SYSTEM** menu lets you change the Operations Manager hostname, perform system upgrades, and reset the system.

Check System Details

To ascertain current system details click on the System link at the top-right of the OM window.

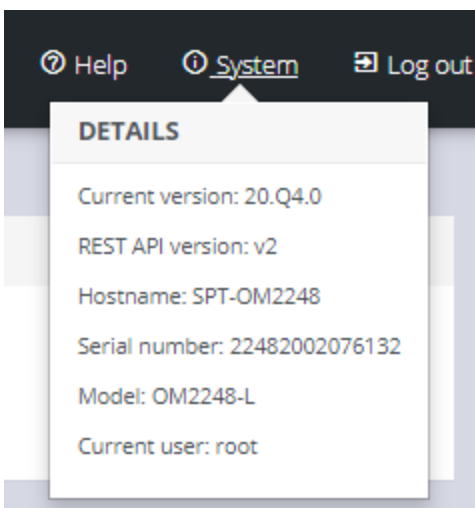

Administration

[CONFIGURE](#) > [SYSTEM](#) > [Administration](#)

To set the hostname, add a contact email, or set a location for the Operations Manager:

1. Click **CONFIGURE** > **SYSTEM** > **Administration**.
2. Edit the **Hostname** field.

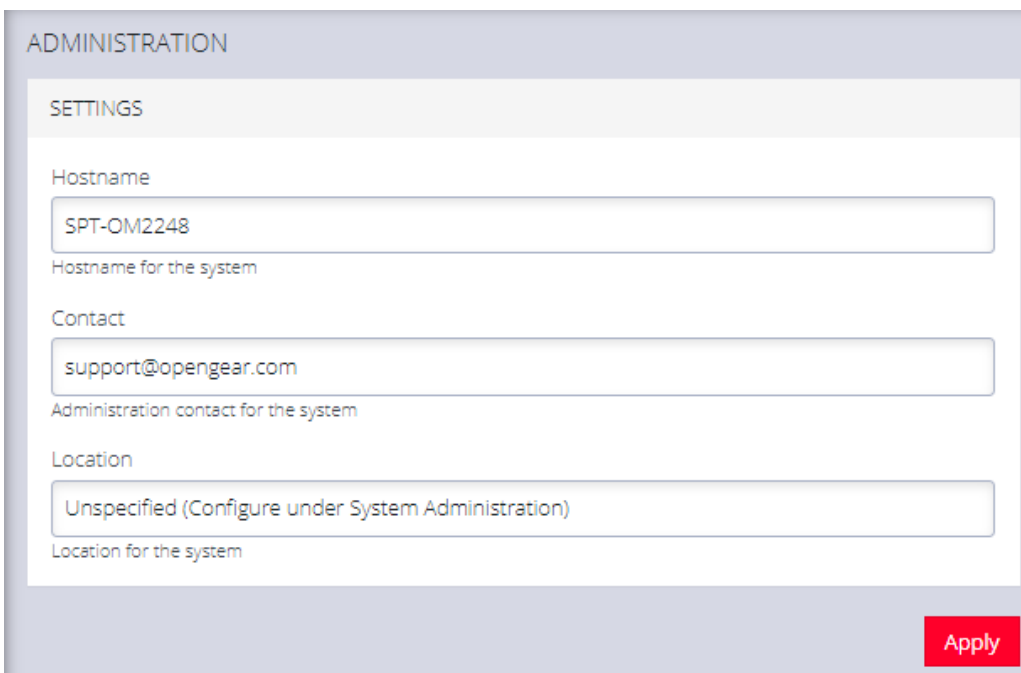

The screenshot shows the 'ADMINISTRATION' settings page. It features three input fields under the 'SETTINGS' section:

- Hostname:** The input field contains 'SPT-OM2248'. Below it is the text 'Hostname for the system'.
- Contact:** The input field contains 'support@opengear.com'. Below it is the text 'Administration contact for the system'.
- Location:** The input field contains 'Unspecified (Configure under System Administration)'. Below it is the text 'Location for the system'.

An 'Apply' button is located in the bottom right corner of the settings area.

3. Click **Apply**, the new settings are saved.

Date & Time

[CONFIGURE > SYSTEM > DATE & TIME > TIME SETTINGS](#)

It is important to set the local Date and Time in your Opengear device as soon as it is configured. Features such as Syslog and NFS logging use the system time for time-stamping log entries, while certificate generation depends on a correct Timestamp to check the validity period of the certificate.

Your Opengear device can synchronize its system time with a remote Network Time Protocol (NTP) server. NTP uses Coordinated Universal Time (UTC) for all time synchronizations so it is not affected by different time zones.

You need to specify your local time zone so the system clock shows correct local time. The Date & Time section of the navigation bar provides a means to

- Set the time zone
- Manually set the correct time and date

Or

- Set the date and time by NTP Server

Continued:

22.11.0	CONFIGURE Menu	190
---------	----------------	-----

Manual Date & Time Set

1. Navigate to CONFIGURE > SYSTEM > DATE & TIME > TIME SETTINGS.
2. Select the applicable local time zone from the global time zone drop-down list, then, select **Manual** in the **Time Zone** section of the page.

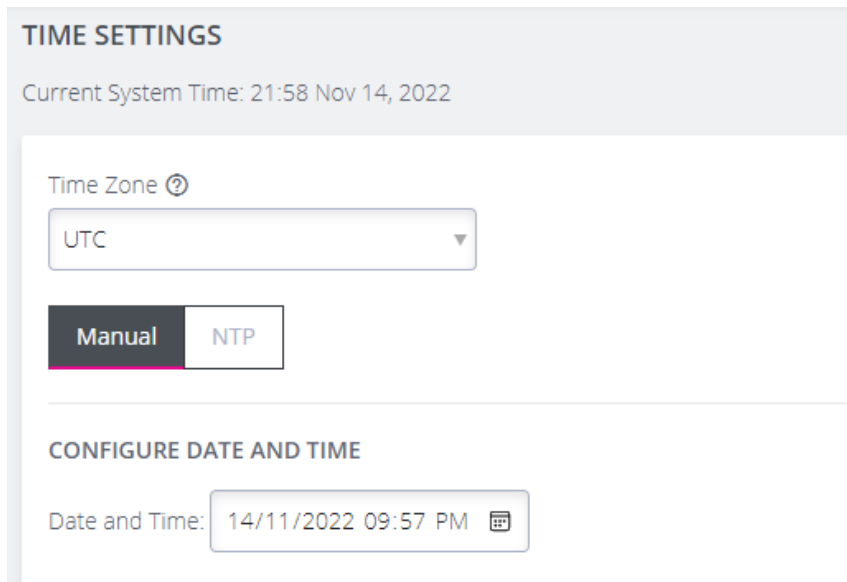

TIME SETTINGS

Current System Time: 21:58 Nov 14, 2022

Time Zone ⓘ

UTC ▼

Manual NTP

CONFIGURE DATE AND TIME

Date and Time: 14/11/2022 09:57 PM 📅

3. Select the correct date and time from the Date/Time Calendar.
4. Click the **Apply Date and Time** button.

NTP Configuration & Authentication

Configuring an NTP server ensures the Opengear device clock is kept accurate (once Internet connection has been established).

When defining an NTP server you can choose to supply an Authentication Key and Authentication Key Identifier or not to use Authentication. If NTP Authentication keys are in use, the NTP server must be verified using the Authentication Key and Authentication Key Index before synchronizing time with the server.

22.11.0	CONFIGURE Menu	191
---------	----------------	-----

1. Navigate to CONFIGURE > SYSTEM > DATE & TIME > TIME SETTINGS.
2. Select the applicable time zone from the global time zone drop-down list, then, select **NTP** in the **Time Zone** section of the page.

Time Zone [?]

UTC ▼

Manual NTP

3. In the **Remote NTP Server List** section of the page, click **Add NTP Server**. The '**Remote NTP Server List**' opens.

Note: If your external NTP server requires authentication, you need to specify the NTP Authentication Key and the Key Index to use when authenticating with the NTP server.

REMOTE NTP SERVER LIST

NTP Server Address [?]

time.cloudflare.com

Authentication required

Yes No

Authentication Key [?]

.....

Key Index [?]

5

Key Format [?]

HEX ▼

Key Hash [?]

SHA1 ▼

⁺ Add NTP Server



4. Enter the IP address of the remote NTP Server.
5. If Authentication is required, select **Yes** and complete all sections of the **Authentication Key** form.
6. Click the **Apply NTP Settings** button.

CLI Commands Associated with NTP Configuration

Generate a new key:

```
chronyc keygen $INDEX $ALGORITHM
```

Examples:

```
chronyc keygen 1 SHA3-512
```

```
chronyc keygen 50 SHA1
```

```
chronyc keygen 2345 AES256
```

Check chronyd service:

```
systemctl status chronyd.service
```

```
journalctl -b 0 --unit chronyd.service
```

Check if the server has clients

```
chronyc clients
```

Check if the client is synchronizing:

`chronyc sources` - shows a list of servers available to the system, status, and offsets from the local clock and the source

`chronyc sourcestats` - show additional statistics for each server



`chronyc tracking` - see what server chrony is tracking with and performance metrics from that server execute

`chronyc activity` - see the number of servers and peers that are connected

`chronyc ntpdata` - returns data about each configured server

Check the NTP packets

`tcpdump -vvv -i any udp port 123`

OM specific CLI Commands

`ogcli get services/ntp`

`ogcli help services/ntp`

`ogcli replace services/ntp enabled=false` - disable NTP and clear all servers and keys.

`ogcli update services/ntp enabled=false` - disable NTP, but keep servers and keys settings.

`cat /etc/config/chronyd.conf`

`cat /etc/config/chronyd.keys`

Factory Reset

[CONFIGURE > SYSTEM > Factory Reset](#)

You can perform a factory reset, where logs and docker containers are preserved and everything else is reset to the factory default.

To return the Operations Manager to its factory settings:

1. Select **CONFIGURE > SYSTEM > Factory Reset**.
2. Read the Factory Reset warning notice.

Warning: This will delete all configuration data from the system and reset all options to the factory defaults. Any custom data or scripts on the node will be lost. Please check the box below to confirm you wish to proceed.

3. If you still wish to proceed with the reset, Select the **Proceed with the factory reset** checkbox.
2. Click **Reset**.

Warning: This operation performs the same operation as the hard factory erase button. This resets the appliance to its factory default settings. Any modified configuration information is erased. You will be prompted to log in and must enter the default administration username and administration password (Username: root Password: default). You will be required to change this password during the first log in.

Reboot

[CONFIGURE](#) > [SYSTEM](#) > [Reboot](#)

To reboot the Operations Manager:

1. Navigate to **CONFIGURE > SYSTEM > Reboot**.
2. Select **Proceed with the reboot**,
3. Click **Reboot**.

REBOOT

WARNING

Please check the box below to confirm you wish to proceed. The appliance will reboot and will be unreachable for several minutes.

Proceed with the reboot

Reboot

Export Configuration

The current system configuration can be downloaded as a plain text file. It contains all configuration performed via the Web UI and the ogcli tool.

It does not contain log files, user scripts, docker containers, service configuration or other files stored via other means.

The exported configuration may be useful for:

- disaster recovery
 - issues with system upgrades
 - unexpected configuration changes
- replacing devices after RMA
- configuration templating

Export Configuration via Web UI

[CONFIGURE](#) > [SYSTEM](#) > [Export / Restore Configuration](#)

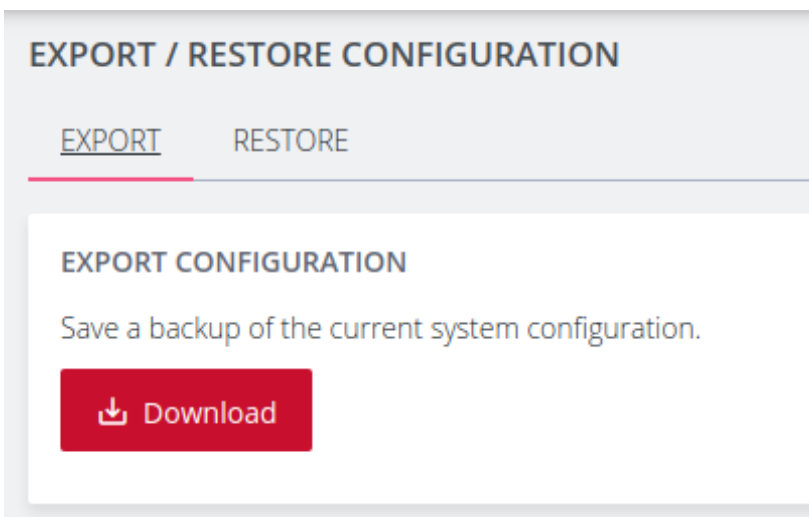

To export the system configuration, click the **Download** button and save this file.

22.11.0	CONFIGURE Menu	197
---------	----------------	-----

Sensitive data such as passwords and tokens will be obfuscated in the configuration export.

Note: The default filename includes the system hostname and a timestamp.
For example, **om2248_20210910_config.txt**

Export Configuration via ogcli

The system configuration can also be exported using the ogcli tool.

As an administrative user, run the following command:

```
ogcli export <file_path>
```

Control The Export Of Sensitive Data

The display of sensitive data during export via ogcli can be controlled by modifying the ogcli command:

- To display secrets in cleartext, run:

```
ogcli --secrets=cleartext export <file_path>
```

- To display obfuscated secrets, run:

```
ogcli --secrets=obfuscate export <file_path>
```

- To display secrets masked with *********, run:

```
ogcli --secrets=mask export <file_path>
```

Caution: Configuration exported with **--secrets=mask** cannot be used to import configuration.



Lighthouse Node Backup

Configuration export can be scheduled to be performed periodically using the Lighthouse Node Backup feature.

For more details, consult the Lighthouse User Guide:

<https://opengear.com/support/documentation/>

22.11.0	CONFIGURE Menu	199
---------	----------------	-----

Restore Configuration

Exported system configuration can be imported to the node using the Web UI or ogcli tool.

Note: If the configuration was exported using `--secrets=mask`, it cannot be used for configuration import.

Note: It may take up to ten minutes to import a config file with a large amount of configuration.

Restore Configuration Via Web UI

[CONFIGURE > SYSTEM > Export / Restore Configuration](#)

Importing configuration using the Web UI will use the restore strategy. Restoring configuration will override all settings on the node.

Only configuration from the same version and model can be restored.

To restore the system configuration:

1. Click the **Restore** tab

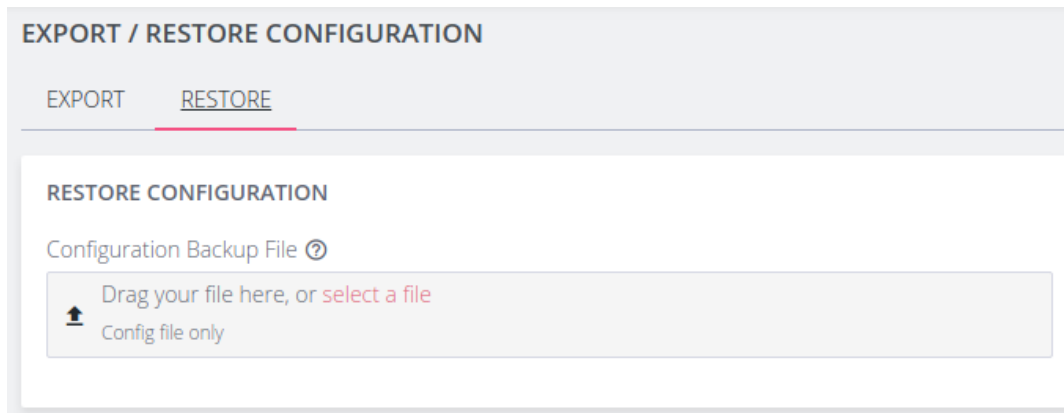

2. Select the configuration file to import.
3. Review the configuration by clicking the arrow to display the file content.

RESTORE CONFIGURATION

Configuration Backup File ⓘ

REVIEW UPLOAD

 cm8148_20210910_config.txt ▼

4. Click the **Upload File** button to start the import process.
5. A green banner will display when the configuration import is successful.



Import Configuration via ogcli

The system configuration can also be imported using the `ogcli` tool. Either the import or restore strategies can be used.

Import Configuration

Configuration that is imported using the `ogcli import` command will be merged with the current system configuration, preserving the current values and adding missing entries from the exported configuration where required.

As an administrative user, run the following command:

```
ogcli import <file_path>
```

Restore Configuration

Configuration that is imported using the `ogcli restore` command will replace the current system configuration. The resulting system configuration will reflect what is in the exported configuration.

As an administrative user, run the following command:

```
ogcli restore <file_path>
```

System Upgrade

[CONFIGURE > SYSTEM > System Upgrade](#)

You can perform a system upgrade when new firmware is released. After specifying the location of the firmware and beginning the upgrade process, the system will be unavailable for several minutes and then reboot. Unlike a factory reset, users, and other configuration data is maintained after the upgrade.

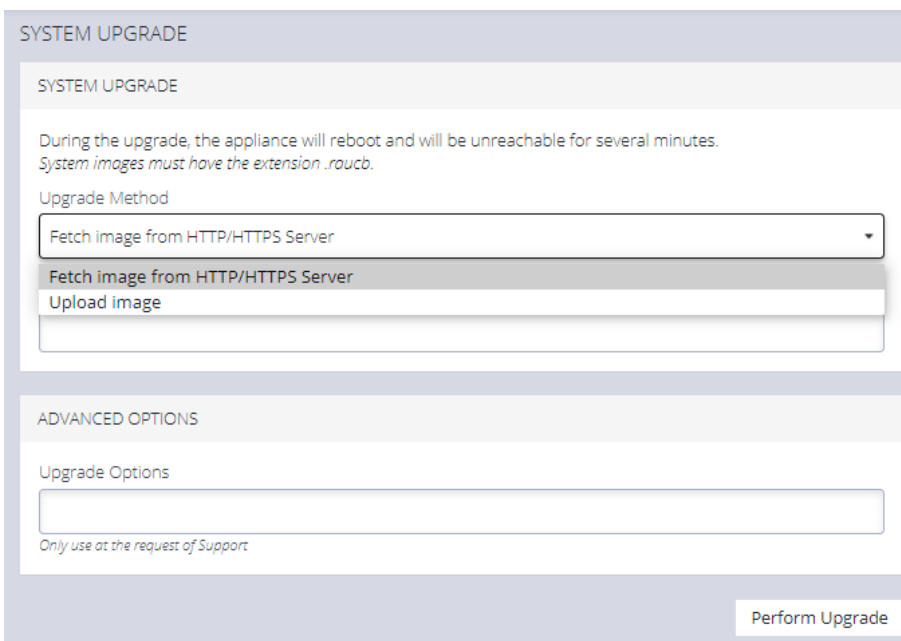

The screenshot shows the 'SYSTEM UPGRADE' configuration page. At the top, it says 'SYSTEM UPGRADE' and provides a warning: 'During the upgrade, the appliance will reboot and will be unreachable for several minutes. System images must have the extension .roucb.' Below this is the 'Upgrade Method' section with a dropdown menu currently set to 'Fetch image from HTTP/HTTPS Server'. An expanded menu shows two options: 'Fetch image from HTTP/HTTPS Server' and 'Upload image'. Below that is the 'ADVANCED OPTIONS' section with a text input field for 'Upgrade Options' and a note: 'Only use at the request of Support'. At the bottom right, there is a 'Perform Upgrade' button.

To perform a system upgrade:

1. Navigate to the **CONFIGURE > System > System Upgrade** page.
2. Select the **Upgrade Method**, either **Fetch image from HTTP/HTTPS Server** or **Upload Image**.

Note: See <https://opengear.com/support/device-updates/> for firmware updates.

Upgrade Via Fetch From Server

If upgrading via **Fetch image from HTTP/HTTPS Server**:

1. Enter the URL for the system image in the **Image URL** text-entry field.
2. Click **Perform Upgrade**.

Upgrade Via Upload

If upgrading via **Upload Image**:

1. Click the **Choose file** button.
2. Navigate to the directory containing the file.
3. Select the file and press **Return**.
4. Click **Perform Upgrade**.

Note: The **Advanced Options** section should only be used if a system upgrade is being performed as part of an OpenGear Support call.

Once the upgrade has started, the System Upgrade page displays feedback as to the state of the process.



Advanced Options

The Operations Manager supports a number of command line interface (CLI) options and REST API.

address : Primary Lighthouse address to enroll with

api_port : Optional port to use for the primary address when requesting enrollment

external_endpoints : List of additional "address:port" endpoints to fall back to when enrolling

password : LH global or bundle enrollment password

bundle : Name of LH enrollment bundle

22.11.0	Advanced Options	205
---------	------------------	-----

Communicating With The Cellular Modem

Interfacing with the cellular modem is currently only available via CLI.

Usage:

`mmcli [OPTION?] - Control and monitor the ModemManager`

Options:

<code>-h, --help</code>	Show help options
<code>--help-all</code>	Show all help options
<code>--help-manager</code>	Show manager options
<code>--help-common</code>	Show common options
<code>--help-modem</code>	Show modem options
<code>--help-3gpp</code>	Show 3GPP related options
<code>--help-cdma</code>	Show CDMA related options
<code>--help-simple</code>	Show Simple options
<code>--help-location</code>	Show Location options
<code>--help-messaging</code>	Show Messaging options
<code>--help-voice</code>	Show Voice options

<code>--help-time</code>	Show Time options
<code>--help-firmware</code>	Show Firmware options
<code>--help-signal</code>	Show Signal options
<code>--help-oma</code>	Show OMA options
<code>--help-sim</code>	Show SIM options
<code>--help-bearer</code>	Show bearer options
<code>--help-sms</code>	Show SMS options
<code>--help-call</code>	Show call options

Application Options:

- `-v, --verbose` Run action with verbose logs
- `-V, --version` Print version
- `-a, --async` Use asynchronous methods
- `--timeout=[SECONDS]` Timeout for the operation

Opengear CLI Guide

The **ogcli** command line tool is used for getting and setting configuration, and for retrieving device state and information. The purpose of ogcli is perform a single operation and exit. Operations are performed on a single entity, a list of entities, or all entities. Entities in ogcli are collections of related information items that represent device state, information or configuration.

For a list of operations supported by ogcli, see the "[ogcli Operations](#)" section.

Note: ogcli is not an interactive shell, it runs a single command and exits.

Getting Started with ogcli

The best way to get started with ogcli is to use the help command. Refer to the table below to access help topics within ogcli.

For detailed information about ogcli and how it works, view the ogcli help topic by running this command:

```
ogcli help ogcli
```

Access ogcli Help and Usage Information

Help Command	Displays...
ogcli help	Basic ogcli help and usage information
ogcli help help	Detailed information about the help command
ogcli help operations	The full list of operations and a brief description of each
ogcli help entities	The full list of entities and a brief description of each

Help Command	Displays...
ogcli help syntax	How to get information into and out of ogcli
ogcli help ogcli	More detailed information about the ogcli tool
ogcli help usage	Common ogcli usage examples
ogcli help secrets	Detailed information about controlling the display of secrets in ogcli.
ogcli help <operation>	A description and example usage of a specific ogcli operation
ogcli help <entity>	A description of a specific entity and the operations it supports
ogcli help <entity> <operation>	An example of how to perform a specific operation on a specific entity

Basic Syntax

The ogcli tool is always called with an operation, with most operations also taking one or more arguments specifying an entity for the operation to act on.

```
ogcli <operation> [argument] [argument]
```

ogcli Operations

Operation	Description
get	Retrieve a list or single item
replace	Replace a list or single item

Operation	Description
update	Update an item, supports partial edits
merge	Merge a provided list with existing config
create	Create an item
help	Display ogcli help
export	Export the system configuration
import	Import system configuration, merging with current system configuration
restore	Import system configuration, replacing the current system configuration

Supplying Data To ogcli

For operations that modify an entity (e.g. 'update') the new information can be passed as inline positional arguments, but this quickly becomes cumbersome when setting a large number of fields. Information can instead be supplied through stdin by piping the contents of a file, or with Here Document (heredoc) style. The heredoc style is the most flexible format and is used extensively in ogcli examples.

Here Document

A here document (heredoc) is a form of input redirection that allows entering multiple lines of input to a command. The syntax of writing heredoc takes the following form:

```
ogcli [command] << 'DELIMITER'  
  
HEREDOC  
  
DELIMITER
```

- The first line starts with the `ogcli` command, followed by the special redirection operator `<<` and a delimiting identifier. Any word can be used as the delimiter, commonly 'EOF' or 'END'.
- The `HEREDOC` block can contain multiple lines of strings, variables, commands or any other type of input. Each line can specify one field to update.
- The last line ends with the delimiting identifier used above, indicating the end of input.

```
ogcli update user <username> << 'END'  
  description="operator"  
  enabled=false  
END
```

Inline Arguments

Field data can be entered inline with the `ogcli` command as arguments, with each field separated by a space.

```
ogcli update user <username> enabled=false description=\"operator\"
```

Pipes and Standard Input

The data can also be entered via `stdin` by piping the data to the `ogcli` command.

```
echo 'enabled=true description="operator"' | ogcli update user  
<username>
```

Alternatively, you can provide a file via input redirection with `<`.

```
echo 'enabled=true description="operator"' > partial_record
```

```
ogcli update user <username> < partial_record
```

Quoting String Values

All string fields require the argument to be specified with double quotes ". The shell can consume double quotes, so care must be taken when specifying strings to ensure the quotes are passed to ogcli as input.

1. Double quotes in heredoc do not need to be escaped.

```
ogcli update physif <device-identifier> << 'END'
description="test network"
END
```

2. Double quotes within single quotes do not need to be escaped.

```
ogcli update physif user <username> 'description="test user"'
```

3. Double quotes not within single quotes need to be escaped.

```
ogcli update physif user <username> description=\"test user\"
```

Tab Completion

ogcli includes tab completion to assist with typing commands. When entering the start of a command, press the **<tab>** key to complete the phrase to the nearest match.

If there are multiple matches, all options will be displayed for your reference.

```
root@oml208-8e:~# ogcli get cel
cellmodem          system/cell_reliability_test
cellfw/info        cellmodem/sims      system/cellular_logging
```

Displaying Secrets in ogcli

Fields containing sensitive information are called **secrets**, which are handled specially by **ogcli** to obfuscate their values when they are displayed or exported.

Passwords and private keys are examples of secret fields.

The obfuscation process provides protection against "casual observation" only and offers no cryptographic security. The **obfusc** tool can be used to obtain the clear text version of any obfuscated secret generated by any Operations Manager.

For more information, view the secrets help topic by running:

```
ogcli help secrets
```

The default behavior is for secrets to be passed to ogcli in clear text, and exported or displayed in obfuscated form.

For example, setting the password:

```
ogcli update services/snmpd auth_password=\"my secret\"
```

Retrieving the password (note, the output is abridged):

```
# ogcli get services/snmpd
auth_
password="TkcxJAAAABBSB3xoFWhPA6B7sDrzq3HwaTOAO/jsURqFa0qa7hc3TA=="
```

This behaviour can be overridden to display sensitive fields in clear text, obfuscated form, or masked form using the **--secrets** option. The clear text and obfuscated forms are also accepted when supplying a sensitive field.

```
# ogcli --secrets=cleartext get snmpd
auth_password="my_secret"
```

```
# ogcli --secrets=obfuscate get snmpd  
auth_password="my secret"
```

```
# ogcli --secrets=mask get snmpd  
auth_password="*****"
```

If an export is performed with the **--secrets=mask** option it is impossible to subsequently import the configuration, because the secrets have been removed.

Common Configuration Examples

These examples contain a variety of notations and usage patterns to help illustrate the flexibility of ogcli. The examples can be copied and pasted into the CLI.

Replace message of the day (MOTD) displayed at login

```
ogcli replace banner banner=\"updated message\"
```

Retrieve user record

```
ogcli get user <username>
```

Update item with field where value is a string

```
ogcli update user <username> description=\"operator\"
```

Update item with field where value is not a string

For example, a numeric or boolean value

```
ogcli update user <username> enabled=true
```

Export system configuration

```
ogcli export <file_path>
```

Import system configuration

```
ogcli import <file_path>
```

Restore system configuration

```
ogcli restore <file_path>
```

Enable local console boot messages

```
ogcli get managementports
```

```
ogcli update managementport mgmtPorts-1 kerneldebug=true
```

Create new user

```
ogcli create user << 'END'  
description="superuser"  
enabled=true  
groups[0]="admin"  
password="test123"  
username="superuser123"  
END
```

Change root password

```
ogcli update user root password=\"oursecret\"
```

Create new administrative user

```
ogcli create user << 'END'  
  username="adal"  
  description="Ada Lovelace"  
  enabled=true  
  no_password=false  
  groups[0]="groups-1"  
  password="oursecret"  
END
```

Manually set date and time

```
ogcli update system/timezone timezone="America/New_York"
```

```
ogcli update system/time time="15:30 Mar 27, 2020"
```

Enable NTP service

```
ogcli update services/ntp << 'END'  
  enabled=true  
  servers[0].value="0.au.pool.ntp.org"  
END
```

Update system hostname

```
ogcli update hostname hostname="system-hostname"
```

Adjust session timeouts

```
ogcli update system/cli_session_timeout timeout=180
```

```
ogcli update system/webui_session_timeout timeout=180
```

Setup remote authentication with TACACS+

```
ogcli update auth << 'END'  
mode="tacacs"  
tacacsAuthenticationServers[0].hostname="192.168.250.21"  
tacacsMethod="pap"  
tacacsPassword="tackey"  
END
```

Setup remote authentication with Radius

```
ogcli update auth << 'END'  
mode="radius"  
radiusAuthenticationServers[0].hostname="192.168.250.21"  
radiusAccountingServers[0].hostname="192.168.250.21"  
radiusPassword="radkey"  
END
```

Create user group with limited access to serialports

```
ogcli create group << 'END'
  description="Console Operators"
  groupname="operators"
  role="ConsoleUser"
  mode="scoped"
  ports[0]="ports-10"
  ports[1]="ports-11"
  ports[2]="ports-12"
END
```

View and configure network connections

```
ogcli get conns
```

```
ogcli get conn system_net_conns-1
```

```
ogcli update conn system_net_conns-1 ipv4_static_
settings.address="192.168.0.3"
```

```
ogcli create conn << 'END'
  description="2nd IPv4 Static Address Example"
  mode="static"
  ipv4_static_settings.address="192.168.33.33"
  ipv4_static_settings.netmask="255.255.255.0"
  ipv4_static_settings.gateway="192.168.33.254"
  physif="net1"
END
```

Configure serial ports

```
ogcli get ports
```

```
ogcli get ports | grep label
```

```
ogcli get port ports-1
```

```
ogcli update port "port05" << 'END'  
mode="consoleServer"  
label="Router"  
pinout="X2"  
baudrate="9600"  
databits="8"  
parity="none"  
stopbits="1"  
escape_char("~"  
ip_alias[0].ipaddress="192.168.33.35/24"  
ip_alias[0].interface="net1"  
logging_level="eventsOnly"  
END
```

Enable cellular modem interface

```
ogcli get physifs
```

```
ogcli update physif wwan0 << 'END'  
enabled=true  
physif.cellular_setting.apn="broadband"  
physif.cellular_setting.iptype="IPv4v6"  
END
```

Disable cellular modem interface

```
ogcli update physif physif wwan0 enabled=false
```

Enable remote syslog service

```
ogcli create services/syslog_server address="\192.168.34.112\"
```

```
ogcli create services/syslog_server << 'END'  
address="192.168.34.113"  
protocol="UDP"  
port=514  
END
```

Config Shell Guide

The Config Shell feature provides an interactive and familiar environment similar to older Opengear appliances. The result is an user-experience that feels like an Interactive CLI.

Advantages of the Config Shell are:

- Items can be created or updated without being applied immediately
- Items that are not applied are indicated by an asterisk (*) beside them when viewing information.
- Tab complete is supported for many commands.
- Built-in help (see "[Global Context Commands](#)" on page 225).
- Has a structured, tabular view when displaying lists of data.

Start and End a Config Shell Session

Start the config shell by typing `config` at a bash prompt. The bash prompt is presented to root and admin users when they log in via SSH or on the maintenance console.

You can exit the Config Shell by any of the following:

- Type `exit` to end the session.
- Send an EOF (**Control+D**).
- Send an INT (**Control+C**).

Note: The session is prevented from exiting if there are un-committed changes, this condition is indicated by a message. However, you can force an exit by immediately executing an exit command again, any un-committed changes will be discarded.

Navigate in the Config Shell

The Config Shell operates in a hierarchy of entities. Due to the variety of entities, there are several ways for you to get to a place where you can make changes.

Starting at the root, enter the entity names to descend down through lower entities. Every entity name is an operation that descends into that entity. Similarly, type the names of entities higher in the hierarchy to ascend towards the root.

Identifiers:

Singleton entity	Require only the entity name to be uniquely identified.
List/item entity	The first level is the entity name, the second level is the item identifier (the identifier is the same identifier used by ogcli).
Multiple identifiers	A single entity (ssh/authorized_keys) requires an extra identifier. In this case, the hierarchy is: ssh/authorized_keys > userid > [key_id] .
Nested fields	The Config Shell treats nested fields as additional hierarchy levels. This applies both to arrays and maps. For arrays of complex values, each value shall also be a hierarchy level.

Fields, Entities and Contexts

The config shell allows you to configure a number of fields which define settings.



The fields are grouped in entities that describe a small set of functionality. For example, there is a 'user' entity which is used to access user settings. Entities can contain sub-entities as well as simple fields.

Context Within Config Shell

Once in the shell, a number of commands are available depending on the current context. The context is the current entity that is the focus of the config shell. When the shell is first started, the context is a special parent context from which sub-entities can be seen.

Once a context is selected by typing the name of the entity, it is shown in the prompt between brackets. For example, in the following snippet, the 'user' context is accessed and then the 'john' sub-entity is accessed causing the context to become 'user john'. The 'show' command is used to list the entities and fields that descend from the current context.

```
config: user
config(user): show
Item names for entity user
  john matt myuser netgrp root
config(user): john
config(user john):
Entity user item john
  description
  enabled true
  no_password false
  password
  ssh_password_enabled true
  groups (array)
config(user john):
```

Global Context Commands

The following commands are available on any context:

help (or '?')	Show help which is context sensitive. It will list some special details about the current context, the list of sub entities (or fields) and a list of available commands.
help <entity>	Show the help for the specific entity.
help <field>	Show the help for the specific field.
show	List the available entities and fields.
<entity>	Typing the name of an entity changes the context to focus on the named entity.
exit	Exit the command shell.

Entity Context Commands

The following commands available on any entity context:

<field>	Show the value of a field.
<field> <value>	Change the field to the specific value.
delete	Delete the current entity. This is available when the context entity is an item in a list.
add	Append a sub entity or field to the current entity. This is only available when the context entity is a list.

Apply or Discard Field Changes

When fields and entities are changed, they are not yet applied to the system configuration but are kept staged. Items that are staged are indicated with an '*' when the `show` command is used. In addition, the `changes` command can be used to show what fields have been changed.

In the following example, the user 'john' has been changed to alter the description. The `show` command indicates the changed field with an '*'. The `changes` command lists the changed field.

```
config(user john): description "Admin"
config(user john): show
Entity user item john
  description Admin *
  enabled true
  no_password false
  password
  ssh_password_enabled true
  groups (array)
config(user john): changes
Entity user item john (edit)
  description Admin
config(user john):
```

Operations

Once a change has been made, the following commands are available:

changes	show staged changes on all entities
apply	apply changes only on the current entity
discard	discard changes only on the current entity
apply all	apply changes on all entities
discard all	discard changes on all entities

Supported Entities

The following entities are supported in phase 1 of this feature and are available in release 22.06.0:

auth	Configure remote authentication, authorization, accounting (AAA) servers.
group	Retrieve or update user group information.
ip_passthrough	Passthrough entities are for retrieving / changing IP Passthrough settings.
ip_passthrough/status	The IP Passthrough status entity provides information about what part of the IP Passthrough connection process the device is currently at and information about the connected downstream device.
local_password_policy	Configure the password policy for local users. This includes expiry and complexity settings.

logs/portlog_settings	Check and update port log settings.
managementport	Used for working with local management console information.
port	Configure and view ports information.
ports/auto_discover/schedule	Manage Port Auto-Discovery scheduling.
system/admin_info	Retrieve or change the Operations Manager appliance system's information (hostname, contact and location).
system/banner	Retrieve or change the Operations Manager appliance system's banner text.
system/cloud_connect	Retrieve or change the Operations Manager appliance system's cloud connect configuration.
system/model_name	Retrieve the Operations Manager appliance's Model Name.
system/serial_number	Retrieve the Operations Manager appliance's Serial Number.
system/session_timeout	Retrieve or change the Operations Manager appliance session timeouts.
system/ssh_port	The SSH port used in Direct SSH links.
system/time	Retrieve and update the Operations Manager's time.
system/timezone	Retrieve and update the system's timezone.
system/version	Retrieve the Operations Manager's most recent firmware and REST API version.

user	Retrieve and update user information.
-------------	---------------------------------------

Example CLI Commands

Adding a User

In this example below, some commentary is added. Commentary added later is denoted with a `//` prefix.

```
# config
Welcome to the Opengear interactive config shell. Type ? or help for
help.
// Move to the user entity
```

```
config: user
config(user): help add
Add a new item for entity user.

The add command requires a unique value to identify the record.
This will be used for the username field.

Description for the item:
  Retrieve and update information for a specific user.

// Create the new user

config(user): add matt
config(user matt): show
Entity user item matt
  description
  enabled true
```

22.11.0	Advanced Options	229
---------	------------------	-----

```
no_password false
password (required)
ssh_password_enabled true
username matt
groups (array)
```

```
// Fill out some fields

config(user matt): password secretpassword
config(user matt): description Admin
config(user matt): show
Entity user item matt
  description Admin *
  enabled true
  password secretpassword *
  ssh_password_enabled true
  username matt
  groups (array)
```

```
// Edit the groups
config(user matt): groups
config(user matt groups): show
Entity user item matt field groups
config(user matt groups): add // Tab completion to show available
values
admin myuser netgrp
config(user matt groups): add admin
config(user matt groups): up // Exit the groups list
```

```
// Show and apply
config(user matt): show
Entity user item matt
  description Admin *
  enabled true
  password secretpassword *
  ssh_password_enabled true
  username matt
  groups (array)
  0 admin *
config(user matt): apply
Creating entity user item matt.
config(user matt):
```

Configuring a Port

```

config: port
config(port): help
You are here: entity port
Description for the entity:
    Configuring and viewing ports information

Names (type <name> or help <name>)
=====
USB-A  USB-E  USB-front-lower  port03  port07  port11  port15  port19  port23
USB-B  USB-F  USB-front-upper  port04  port08  port12  port16  port20  port24
USB-C  USB-G  port01           port05  port09  port13  port17  port21
USB-D  USB-H  port02           port06  port10  port14  port18  port22

Commands (type help <command>)
=====
exit  help  show  up
config(port): port01
config(port port01): baudrate // tab completion
110   1200   150   19200  230400  300   4800   57600   75
115200 134   1800   200   2400   38400  50    600    9600
config(port port01): baudrate 57600
config(port port01): label Router
config(port port01): control_code
config(port port01 control_code): break a
config(port port01 control_code): up
config(port port01): show
Entity port item port01
  baudrate      57600      *
  databits      8
  escape_char   ~
  label         Router    *
  logging_level disabled
  mode          consoleServer
  parity        none
  pinout        X2
  stopbits      1
  control_code (object)
    break      a *
    chooser
    pmhelp
    portlog
    power
    quit
  ip_alias (array)
config(port port01): apply
Updating entity port item port01.
config(port port01):

```

Advanced Portmanager PM Shell Guide

The Portmanager program allows you to access any serial port on the console server using `pmshell` commands. It

- Routes network connection to serial ports
- Checks permissions
- Monitors and logs all the data flowing to/from the ports
- Allows you to run power commands if the serial port is associated with a PDU outlet.

Running `pmshell`

`pmshell` provides an environment that allows you to access and interact with serial ports via a number of command sequences. It lets you navigate between ports using the chooser command (`~m`). For example, you can use `pmshell` to connect to port 8 via the portmanager via the following command line sequence.

```
# pmshell -l port08
```

pmshell Commands

When running `pmshell` there are a number of command sequences that you can use that begin with the `~` key.

Note: Note: If you are connected to `pmshell` via SSH, you must add an additional `~` escape sequence.

Options	Name	Result
<code>~b</code>	break	Generates a BREAK on the serial port (if you're doing this over ssh, you'll need to type " <code>~~b</code> ").
<code>~h</code>	portlog	Generates a history on the serial port. Displays the traffic logs for the port - must have port logging enabled.
<code>~.</code>	quit	Quits pmshell.
<code>~p</code>	power	Opens the power menu for the port. The port must be configured for a PDU
<code>~u</code>		Opens the list of user sessions, select by number to disconnect.
<code>~m</code>	chooser	Connects to the port menu - go back to the serial port selection menu.
<code>~?</code>	pmhelp	Displays help message.

Custom Control Codes for Serial Ports

Custom control codes can be defined for ease of use per port or can be applied to all ports. For example, users could define a different Power Menu control code for every port, while having a single control code for View History that applies to all ports.

Custom control codes can be used by any user with access to the serial port. In order to run the shortcuts, the user presses the CTRL key + the keycode.

Note: Only Admin users can specify short-cut control codes.

Configure Custom Control Codes

Admin users can configure control codes for any of the `pmshell` commands through the REST API, `ogcli` and the new interactive config shell.

Control code limitations are as follows:

- Cannot set multiple control codes for a port to use the same keycode
- The available key codes are a-z, excluding 'i' and 'm' as these can be triggered by commonly used keys TAB and BACKSPACE.

To disable a certain control code for an individual port, set the port's control code to an empty string.

Configure Control Codes for a Specified Port (CLI Examples)

Control Codes Action	CLI Examples
<p>Set control codes for a given port. In this example, the user sets multiple control codes for port 2</p>	<pre data-bbox="683 415 1390 772">ogcli update port port02 << 'END' control_code.break="b" control_code.chooser="c" control_code.pmhelp="h" control_code.portlog="l" control_code.power="p" control_code.quit="q" END</pre>
<p>Clear all control codes for a given port, in this example, port 2</p>	<pre data-bbox="683 827 1390 1142">ogcli update port port02 << 'END' control_code.break="" control_code.chooser="" control_code.pmhelp="" control_code.portlog="" control_code.power="" control_code.quit="" END</pre>

Configure a Control Code Value for All Ports

To set a particular control code to one value across all serial ports, admin users can use the script `set-serial-control-codes` from the CLI as follows:

```
set-serial-control-codes CONTROL_CODE KEY
```

where:

- **CONTROL_CODE** - Must be one of the following values: `break`, `chooser`, `pmhelp`, `portlog`, `power` or `quit`.
- **KEY** - Must be a single lower case letter a-z excluding 'i' and 'm' or an empty string designated by `''` which is used to clear the control code.

Control Codes for All Ports via CLI (Examples)

Control Codes Action	CLI Examples
Set chooser control code to CTRL-a on all ports	<pre>set-serial-control-codes chooser a</pre>
Clear chooser control code on all ports	<pre>set-serial-control-codes chooser ''</pre>

Docker

Docker is a tool designed to make it easier to create, deploy, and run applications by distributing them in containers. Developers can use containers to package up an application with all of the parts it needs, like libraries and dependencies, and then ship it out as one package. Docker is running by default on the Operations Manager. You can access commands by typing `docker` in the Local Terminal or SSH.

For more information on Docker, enter `docker --help`.

Cron

Cron service can be used for scheduled cron jobs runs. Daemon can be managed via the `/etc/init.d/crond` interface, and cron tables managed via `crontab`. `Crontab` supports:

Usage:

```
crontab [options] file
```

```
crontab [options]
```

```
crontab -n [hostname]
```

Options:

`-u <user>` define user

`-e` edit user's crontab

`-l` list user's crontab

`-r` delete user's crontab

`-i` prompt before deleting

`-n <host>` set host in cluster to run users' crontabs

`-c` get host in cluster to run users' crontabs

`-x <mask>` enable debugging

To perform start/stop/restart on `crond` service:

```
/etc/init.d/crond start
```



Cron doesn't need to be restarted when crontab file is modified, it examines the modification time on all crontabs and reload those which have changed.

To verify the current crond status:

```
/etc/init.d/crond status
```

To check current cron jobs running with the following command to list all crontabs:

```
crontab -l
```

To edit or create a custom crontab file:

```
crontab -e
```

This opens a personal cron configuration file. Each line can be defined as one command to run. The following format is used:

```
minute hour day-of-month month day-of-week command
```

For example, append the following entry to run a script every day at 3 am:

```
0 3 * * * /etc/config/backup.sh
```

Save and close the file.

Initial Provisioning via USB Key

Also known as “ZTP over USB”, this feature allows provisioning an unconfigured (factory erased) unit from a USB storage device like a thumb drive.

The USB device must contain a filesystem recognized by the OM (currently FAT32 or ext4) with a file named manifest.og in the root directory. This file specifies which provisioning steps will be done. An article with a partial description of the file format is here:

<https://opengear.zendesk.com/hc/en-us/articles/115002786366-Automated-enrollment-using-USB>

The USB device can be inserted any time (before or after power is applied to the unit) and as long as the unit is unconfigured, the ZTP over USB process will be triggered. Here “unconfigured” has the same meaning as for ZTP: no changes made to the ogconfig data store.

Note: Setting the root password on first log in counts as a config change.

The following manifest.og keys are implemented. This provides image installation, Lighthouse enrollment, and arbitrary script execution:

manifest.og contains <key>=<value> pairs. Recognized keys are:

image : Firmware image file name on the USB device's filesystem that will be flashed after boot once the image is validated

script : Configuration script to run

address : Primary Lighthouse address to enroll with

api_port : Optional port to use for the primary address when requesting enrollment



external_endpoints : List of additional "address:port" endpoints to fall back to when enrolling

password : LH global or bundle enrollment password

bundle : Name of LH enrollment bundle

22.11.0	Advanced Options	242
---------	------------------	-----















EULA and GPL

The current Opengear End-User License Agreement and the GPL can be found at <http://opengear.com/eula>.

22.11.0	Advanced Options	243
---------	------------------	-----

UI Button Definitions

The table below provides a definition of the button icons used in the UI.

Button Icon	Definition
	Edit buttons
	Add item (eg. SNMP Manager)
 	VLAN interface or create VLAN interface.
 	Bonded interfaces or create new bond
 	Bridged interfaces or create new bridge
	Standard network interface
	Cellular interface
	Interface with bridge
	Interface with bond
	Bin widget. Delete selected object.

22.11.0	UI Button Definitions	245
---------	-----------------------	-----